

mectron

 **MECTRON**  
PIEZOSURGERY® INSERTS



# PIEZOSURGERY®

THE ORIGINAL  
PIEZOELECTRIC  
BONE SURGERY –  
EVIDENCE-BASED!

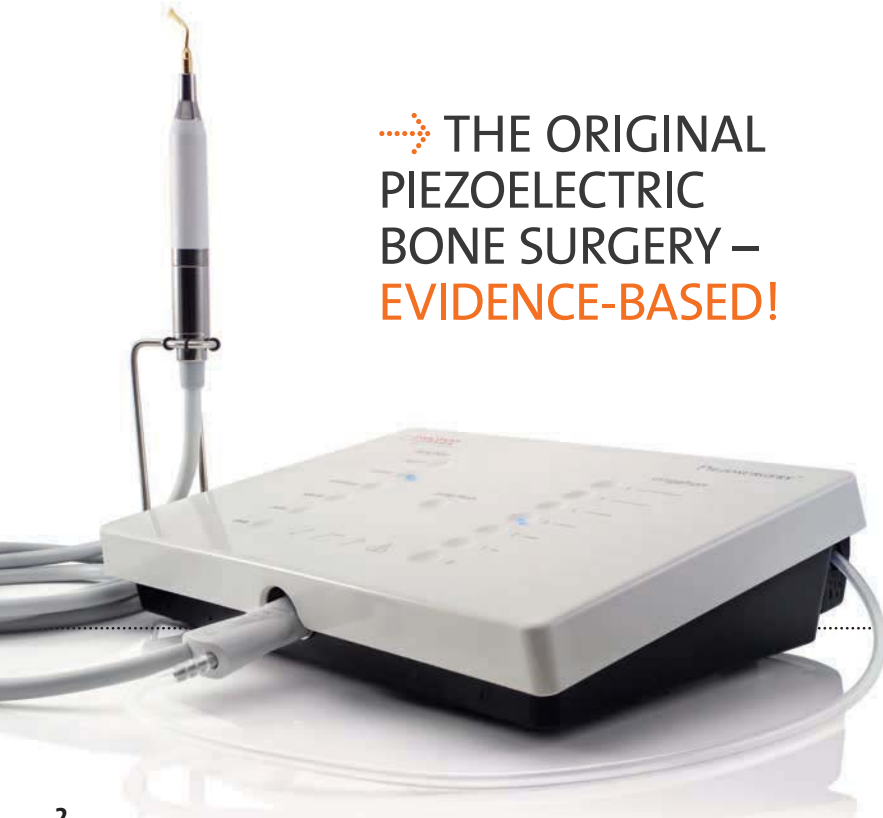

4	PIEZOSURGERY® Technique	36	Insert IM3A - IM3A-15	67	Insert OT11	96	Insert EN3
6	Insert quality	37	Insert IM3P - IM3P-15	68	Insert OT12	97	Insert EN4
8	Indications	38	Insert IM3.4A	69	Insert OT12S	98	Insert EN5R
10	Basic Kit	39	Insert IM3.4P	70	Insert OT13	99	Insert EN5L
11	Osteotomy Kit	40	Insert IM4A	71	Insert OT14	100	Insert EN6R
12	Sinus Lift Lateral Kit	41	Insert IM4P	72	Insert SLO-H	101	Insert EN6L
13	Piezo Lift Kit	42	Insert P2-3	73	Insert PL1	102	Insert EX1
14	Sinus Lift Kit	43	Insert P3-4	74	Insert PL2	103	Insert EX2 - EX3
15	Implant Prep Kit	44	Bone Expanders	75	Insert PL3	104	Insert EXP3-R - EXP3-L
16	Implant Prep Kit Pro	46	Sinus Physiolift® II	76	Insert OP1	105	Insert EXP4-R - EXP4-L
17	Implant Prep Kit Starter	48	Insert IM1 SP	77	Insert OP2	106	Insert PS1
18	Mini Implant Prep Kit	49	Insert IM2 SP	78	Insert OP3 - OP3A	107	Insert PS2
19	Extraction Kit	50	Insert P2-3 SP	79	Insert OP4	108	Insert PS6
20	Explantation Kit	51	Insert MDI 1.9	80	Insert OP5 - OP5A	109	Insert PPI
21	Periodontal Kit	52	Insert MDI 2.2	81	Insert OP6 - OP6A	110	Insert PPI0
22	Resective Perio Kit	53	Insert MDI 2.5	82	Insert OP7	111	Insert PPI1-PP12
23	Retro Surgical Kit	54	Insert OT1	83	Insert OP8	112	Tipholder ICP, tip IC1
24	Bone Expander Kits	55	Insert OT1A	84	Insert OP9	113	Crown prep tips
25	Sinus Physiolift® II Kits	56	Insert OT2	85	Insert SLC	114	Enzymec
26	PIEZOSURGERY® insert box	57	Insert OT3	86	Insert EL1	116	Science
27	Insert Tray	58	Insert OT4	87	Insert EL2	118	Spare Parts
28	Insert IM1S	59	Insert OT5 - OT5A - OT5B	88	Insert EL3	120	Reference Numbers
29	PINS IM1, IM1S, 2-2.4, 2-3	60	Insert OT6	89	Insert SLS	122	Appropriate settings for the inserts
30	Insert IM1 AL	61	Insert OT7 - OT7A	90	Insert SLE1	126	Implant site preparation sequence
31	PINS IM1 AL, 2-2.4 AL, 2-3 AL	62	Insert OT7S-4	91	Insert SLE2		
32	Insert IM2A - IM2A-15	63	Insert OT7S-3	92	Insert PR1		
33	Insert IM2P - IM2P-15	64	Insert OT7-20	93	Insert PR2		
34	Insert IM2.8A	65	Insert OT8R - OT8L	94	Insert EN1		
35	Insert IM2.8P	66	Insert OT9	95	Insert EN2		

# PIEZOSURGERY® TECHNIQUE

PIEZOSURGERY®  
HAS DEFINED A  
NEW DIMENSION  
IN BONE SURGERY



- It's simple, stress-free and selective
- It increases the quality and success for you and your patients



Thanks to the controlled sophisticated ultrasound vibrations, the original PIEZOSURGERY® technique opens up a new age for osteotomy, osteoplasty and extraction in Implantology, Periodontology, Endodontics and Surgical Orthodontics.

- MICROMETRIC CUTS: maximum surgical precision and intra-operative sensitivity
- SELECTIVE CUTS: minimal damage to soft tissue, maximum safety for you and your patients
- CAVITATION EFFECT: maximum intra-operative visibility and a blood-free surgical site
- HISTOLOGICAL ADVANTAGE: more favorable bone healing in osseointegration process

# → INSERT QUALITY



## → PRECISION

A CNC controlled 5-dimensional sharpening machine cuts with an accuracy of up to 0.1  $\mu\text{m}$ .  
The whole cutting process for a single insert last up to 12 min.

## → MATERIAL

mectron ultrasound inserts are built with medical grade, high quality, stainless steel.



---

## → HIGH END INSERTS FOR PROFESSIONALS

Each mectron ultrasound insert will pass through 12 working steps.



### → DIAMOND COATING

Depending on the indication, the inserts are coated with specially selected diamonds. The granulometry of the diamond coating is adapted to the respective treatment.



### → TITANIUM NITRIDE COATING

A coating of titanium nitride, applied to inserts which treat bone, increases the hardness of the surface, avoids corrosion and therefore increases working life.



### → LABELING

Each insert is gently labeled by a laser.

### → QUALITY CHECK

Each insert is checked in detail before getting an OK for the sales.

# INDICATIONS

→ SINUS LIFT TECHNIQUE CRESTAL APPROACH		→ SINUS LIFT TECHNIQUE LATERAL APPROACH		→ IMPLANT SITE PREPARATION		→ MINI DENTAL IMPLANT SITE PREPARATION	→ RIDGE EXPANSION	→ PERIOSTEUM PREPARATION	→ EXTRACTIONS
→ PIEZO-LIFT	→ SINUS PHYSIOLIFT	→ STANDARD	→ STANDARD	→ OPTIONAL	→ STANDARD	→ STANDARD	→ STANDARD	→ STANDARD	→ STANDARD
PL1	IM1 SP	SLC	IM1S	IM1 AL	IM1S	OT7	PR1	EX1	
PL2	IM2 SP	SLO-H	IM2A	IM2A-15	MDI 1.9	OT4	PR2	EX2	
PL3	P2-3 SP	SLS	IM3A	IM2.8A	MDI 2.2	OP5		EX3	
	OT9	SLE1	IM4A	IM3A-15	MDI 2.5	→ OPTIONAL		PS2	
	CS1	SLE2	IM2P	IM3.4A		OT2			
	CS2	OP3	IM3P	IM2P-15		OT7A			
	PIN IM1	OT1	IM4P	IM2.8P		OT7S-4			
	PIN 2-2.4	EL1	OT4	IM3P-15		OT7S-3			
	PROBE SP	→ OPTIONAL	P2-3	IM3.4P		OT7-20			
		OT1A	P3-4			OT12			
		OT5				OT12S			
		OT5A				BONE EXPANDERS			
		OT5B							
		EL2							
		EL3							

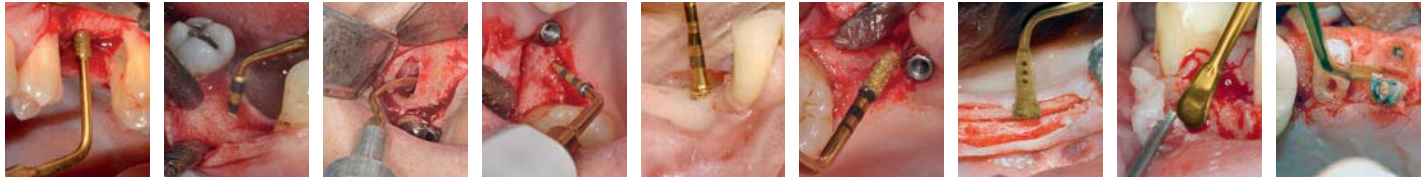



→EXPLANTATION	→BONE BLOCK GRAFTING	→BONE CHIP GRAFTING/BONE MODELING	→ENDODONTICS	→OSTEOTOMY CLOSE TO NERVES	→CORTICOTOMY TECHNIQUE	→PERIODONTAL SURGERY	→CROWN PREPARATION	
→STANDARD	→STANDARD	→STANDARD	→STANDARD	→STANDARD	→STANDARD	→STANDARD	→OPTIONAL	
EXP3-R	OT7	OP3	OP7	OT1	OT7S-4	OP5A	PS1	DB2
EXP3-L	OP5	OP1	PS2	OT5	OT7S-3	OP8	PS6	CROWN PREP TIP
EXP4-R	OT8L	→OPTIONAL	EN1		→OPTIONAL	OP9	PP10	TA12D90* Ø 1.2 mm
EXP4-L	OT8R	OP2	EN2		OT7	OT13	PP11	TA12D60*
	→OPTIONAL	OP3A	EN3		OT7A	OT14	PP12	TA14D120* Ø 1.4 mm
	OT6		EN4			OP5	OP2	TA14D90*
	OT7A		→OPTIONAL			OP3	OP3A	TA14D60*
	OT7S-4		EN5R			PS2	OP4	TA16D120* Ø 1.6 mm
	OT7S-3		EN5L			PP1	OP6	TA16D90*
	OT7-20		EN6R				OP6A	TA16D60*
	OT12		EN6L				ICP + IC1	
	OT12S		OP3					

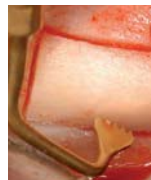

# → BASIC KIT

## → EQUIPPED WITH:

- 1 insert OT7
- 1 insert OT2
- 1 insert EX1
- 1 insert OP1
- 1 insert OP3
- 1 insert tray



→ OT7    → OT2    → EX1    → OP1    → OP3



# → OSTEOTOMY KIT



## → EQUIPPED WITH:

- 1 insert OT7
- 1 insert OT7S-4
- 1 insert OT7S-3
- 1 insert OT8R
- 1 insert OT8L
- 1 insert tray

→ OT7 → OT7S-4 → OT7S-3 → OT8R → OT8L

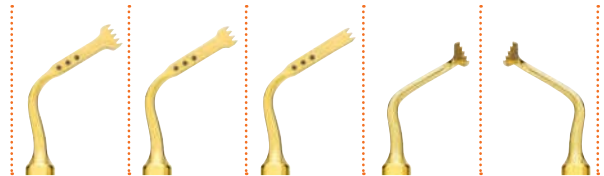

# → SINUS LIFT LATERAL KIT

## → EQUIPPED WITH:

- 1 insert SLC
- 1 insert SLO-H
- 1 insert SLS
- 1 insert SLE1
- 1 insert SLE2
- 1 insert tray



→ SLC    → SLO-H    → SLS    → SLE1    → SLE2



# → PIEZO LIFT KIT



## → EQUIPPED WITH:

- 1 insert PL1
- 1 insert PL2
- 1 insert PL3
- 1 insert tray

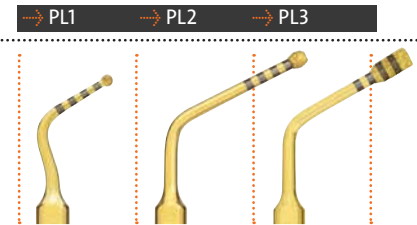

# → SINUS LIFT KIT

## → EQUIPPED WITH:

- 1 insert OT1
- 1 insert OT5
- 1 insert EL1
- 1 insert EL2
- 1 insert EL3
- 1 insert tray



→ OT1    → OT5    → EL1    → EL2    → EL3



# → IMPLANT PREP KIT



## → EQUIPPED WITH:

- 1 insert IM1S
- 1 insert IM2A
- 1 insert IM2P
- 1 insert IM3A
- 1 insert IM3P
- 1 insert OT4
- 1 implant insert tray

→ IM1S → IM2A → IM2P → IM3A → IM3P → OT4

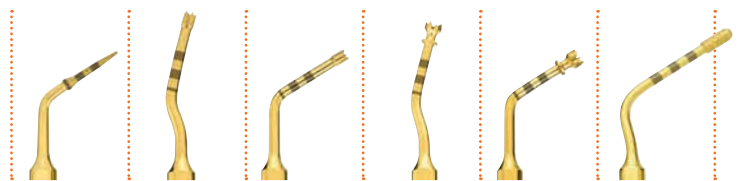

# → IMPLANT PREP KIT PRO

## → EQUIPPED WITH:

- 1 insert IM1S
- 1 insert IM2A
- 1 insert IM2P
- 1 insert IM3A
- 1 insert IM3P
- 1 insert OT4
- 1 insert IM4A
- 1 insert IM4P
- 1 insert P2-3
- 1 insert P3-4
- 3 pins IM1S
- 3 pins 2-2.4
- 1 implant insert tray



→ IM1S → IM2A → IM2P → IM3A → IM3P → OT4 → IM4A → IM4P → P2-3 → P3-4 → PIN IM1S → PIN 2-2.4

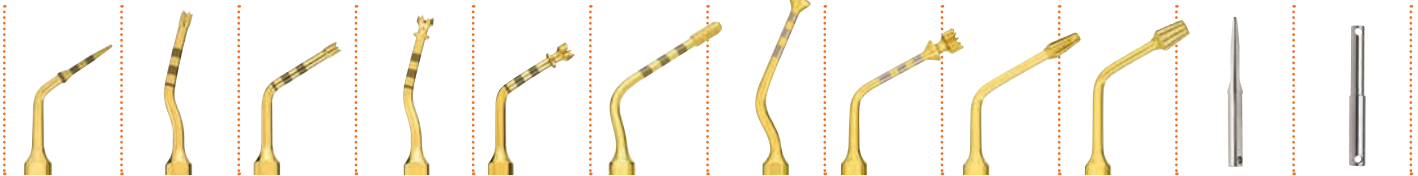



# → IMPLANT PREP KIT STARTER



## → EQUIPPED WITH:

- 1 insert IM1S
- 1 insert IM2P
- 1 insert IM3P
- 1 insert OT4
- 1 insert P2-3
- 1 insert tray

→ IM1S    → IM2P    → IM3P    → OT4    → P2-3

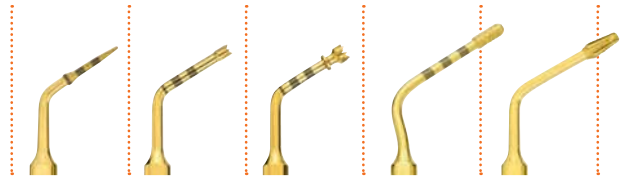

# → MINI IMPLANT PREP KIT

## → EQUIPPED WITH:

- 1 insert IM1S
- 1 insert MDI 1.9
- 1 insert MDI 2.2
- 1 insert MDI 2.5
- 1 insert tray



→ IM1S → MDI 1.9 → MDI 2.2 → MDI 2.5

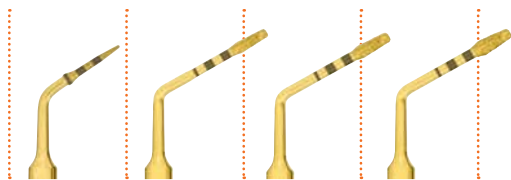

# → EXTRACTION KIT



## → EQUIPPED WITH:

- 1 insert EX1
- 1 insert EX2
- 1 insert EX3
- 1 insert PS2
- 1 insert PS6
- 1 insert tray

→ EX1    → EX2    → EX3    → PS2    → PS6

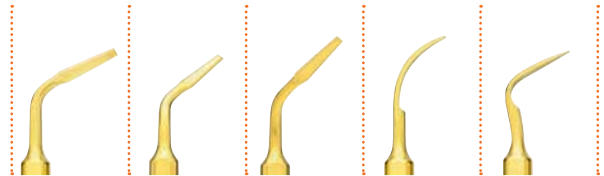

# → EXPLANTATION KIT

## → EQUIPPED WITH:

- 1 insert EXP3-R
- 1 insert EXP3-L
- 1 insert EXP4-R
- 1 insert EXP4-L
- 1 insert tray



→ EXP3-R → EXP3-L → EXP4-R → EXP4-L



# → PERIODONTAL KIT

## → EQUIPPED WITH:

- 1 insert PS2
- 1 insert OP5
- 1 insert PP1
- 1 insert OP3
- 1 insert OP3A
- 1 insert tray

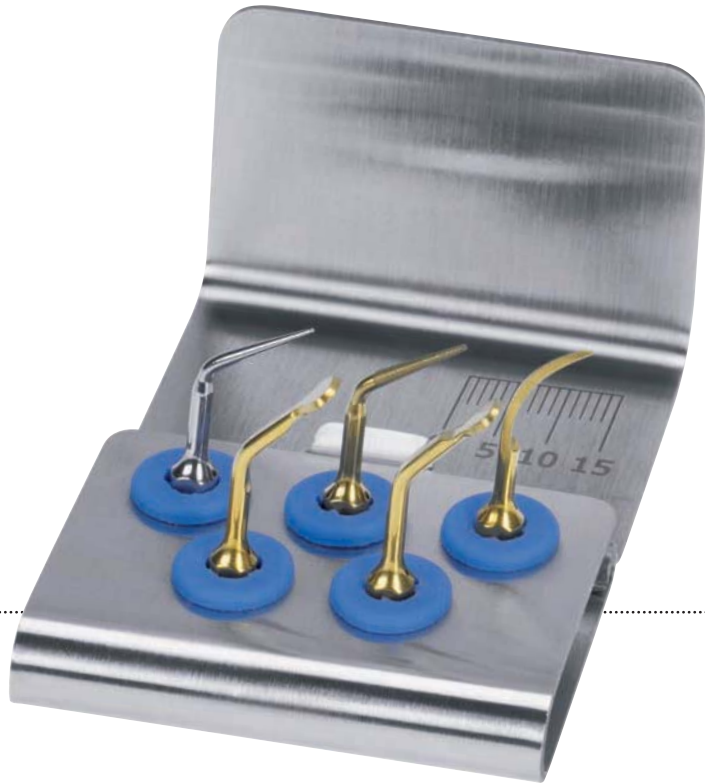

→ PS2    → OP5    → PP1    → OP3    → OP3A



# RESECTIVE PERIO KIT

## → EQUIPPED WITH:

- 1 insert OT13
- 1 insert OT14
- 1 insert OP5A
- 1 insert OP8
- 1 insert OP9
- 1 insert tray



→ OT13 → OT14 → OP5A → OP8 → OP9

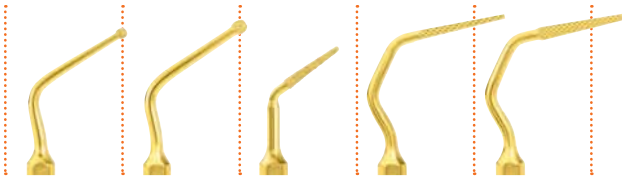

# RETRO SURGICAL KIT



## → EQUIPPED WITH:

- 1 insert OP7
- 1 insert EN1
- 1 insert EN3
- 1 insert EN5R
- 1 insert EN5L
- 1 insert tray

→ OP7 → EN1 → EN3 → EN5R → EN5L



# → BONE EXPANDER KITS

## BONE EXPANDER KIT

### → EQUIPPED WITH:

- 1 expander of each type
- 1 ADM8
- 1 bone expander tray



## BONE EXPANDER KIT PRO

### → EQUIPPED WITH:

- 1 expander of each type
- 1 ADM8, 1 ADR16, 1 ADR7
- 1 ratchet
- 1 bone expander tray



## BONE EXPANDER KIT PRO S

### → EQUIPPED WITH:

- 2 expanders of each type
- 1 ADM8, 1 ADR16, 1 ADR7
- 1 ratchet
- 1 bone expander tray



→ 2.5x11.5 → 3.5x11.5 → 4.5x11.5 → 2.5x15 → 3.5x15 → 4.5x15 → ADM8 → ADR16 → ADR7 → RATCHET





# → SINUS PHYSIOLIFT® II KITS

## SINUS PHYSIOLIFT® II KIT STARTER

### → EQUIPPED WITH:

Crestal sinus elevators 1 x CS1 and 1 x CS2  
 Pressure control system: Physiolifter  
 Micromotor adapter: ADM10  
 1 silicone tube with tube-tube connector  
 1 complete sealed tube  
 1 sterile disposable syringe  
 1 insert tray  
 Clinical Protocol and DVD

## SINUS PHYSIOLIFT® II KIT BASIC

### → EQUIPPED WITH:

Crestal sinus elevators 2 x CS1 and 2 x CS2  
 Pressure control system: Physiolifter  
 Ball shaped probe PROBE SP  
 Micromotor and ratchet adapters:  
 ADM10, ADR10  
 Ratchet  
 3 silicone tubes with tube-tube connector  
 2 complete sealed tubes  
 3 sterile disposable syringes  
 2 insert trays  
 Clinical Protocol and DVD

## SINUS PHYSIOLIFT® II KIT PRO

### → EQUIPPED WITH:

PIEZOSURGERY® inserts: IM1 SP, IM2 SP, P2-3 SP, OT9  
 Alignment pins: PIN IM1, PIN 2-2.4  
 Crestal sinus elevators 2 x CS1 and 2 x CS2  
 Pressure control system: Physiolifter  
 Ball shaped probe PROBE SP  
 Micromotor and ratchet adapters:  
 ADM10, ADR10  
 Ratchet  
 3 silicone tubes with tube-tube connector  
 2 complete sealed tubes  
 3 sterile disposable syringes  
 3 insert trays  
 Clinical Protocol and DVD

→ CS1 → CS2 → PHYSIOLIFTER → ADR10 → ADM10 → RATCHET → PLUG → PROBE SP → IM1 SP → IM2 SP → P2-3 SP → OT9



# PIEZOSURGERY® INSERT BOX



- fully autoclavable
- perfect storage of all PIEZOSURGERY® inserts
- light, easy to use, compact and roomy

# → INSERT TRAY



- stainless steel tray with depth markings
- for sterilisation and storage

→ CUTTING ACTION

bone perforation

→ CLINICAL APPLICATION

initial pilot osteotomy

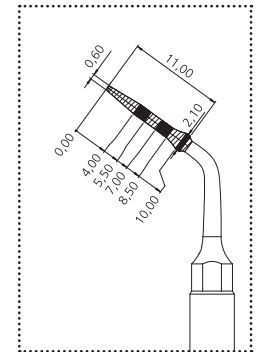
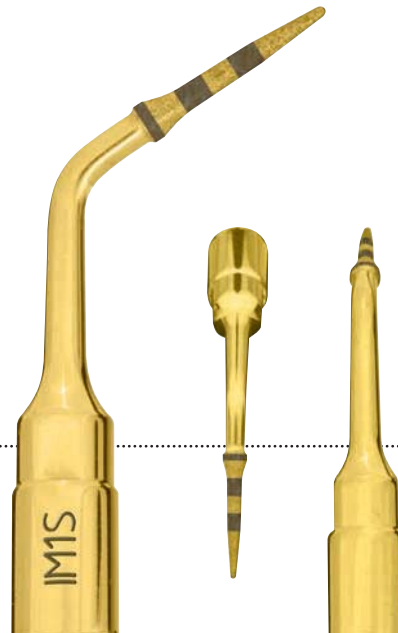

diamond grain size 30 µm



# IM1 AL

insert for initial osteotomy in extraction sites

→ CUTTING ACTION

bone perforation

→ CLINICAL APPLICATION

initial pilot osteotomy in extraction sites

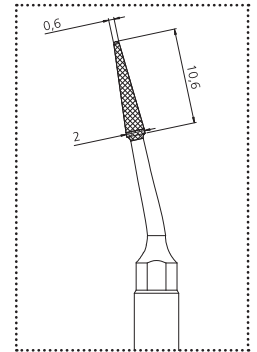
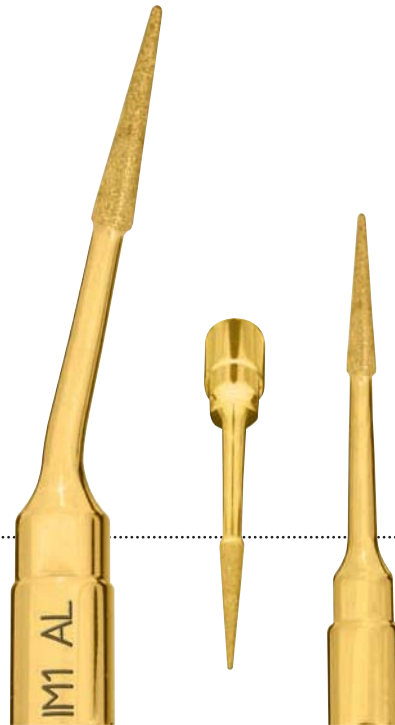

diamond grain size 30 µm

# → ALVEOLAR PINS IM1 AL, 2-2.4 AL, 2-3 AL

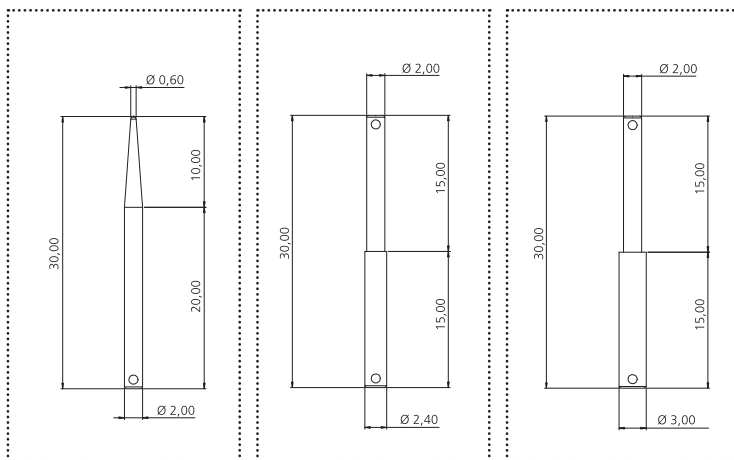

## → DESCRIPTION

30 mm alignment pins, for extraction sites dedicated to IM1 AL, IM2A ( $\varnothing 2$ ), OT4 ( $\varnothing 2.4$ ), IM3A ( $\varnothing 3$ )

## → CLINICAL APPLICATION

to check preparation axis alignment



→ PIN IM1 AL

→ PIN 2-2.4 AL

→ PIN 2-3 AL

# IM2A – IM2A-15

2 mm Ø implant site preparation insert

→ CUTTING ACTION  
bone perforation

→ CLINICAL APPLICATION  
pilot osteotomy in anterior region

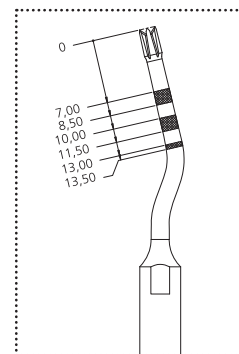



## 2 mm Ø implant site preparation insert

# → IM2P – IM2P-15

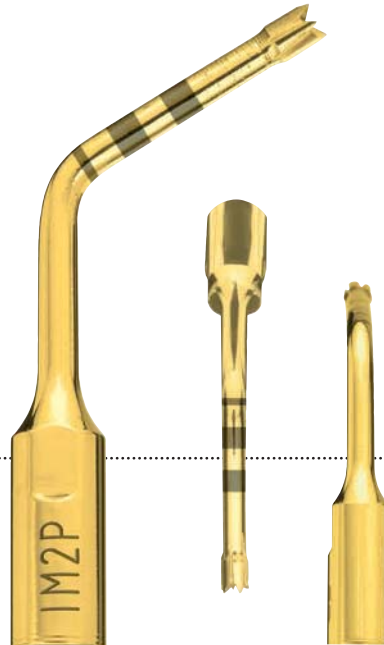
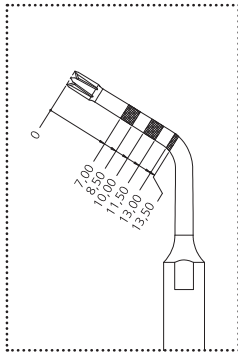

→ CUTTING ACTION

bone perforation

→ CLINICAL APPLICATION

pilot osteotomy in posterior region



# IM2.8A

## 2.8 mm $\emptyset$ implant site preparation insert

### → CUTTING ACTION

bone perforation

### → CLINICAL APPLICATION

to enlarge or to finalize the implant site preparation; insert with double irrigation to avoid overheating

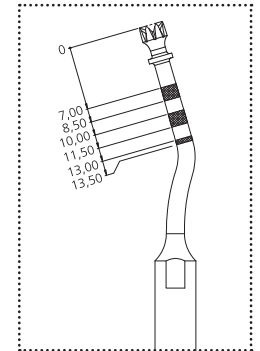
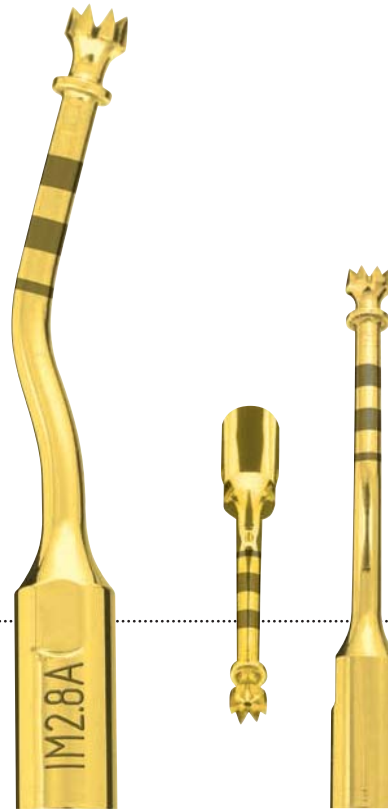

## 2.8 mm $\varnothing$ implant site preparation insert

→ IM2.8P

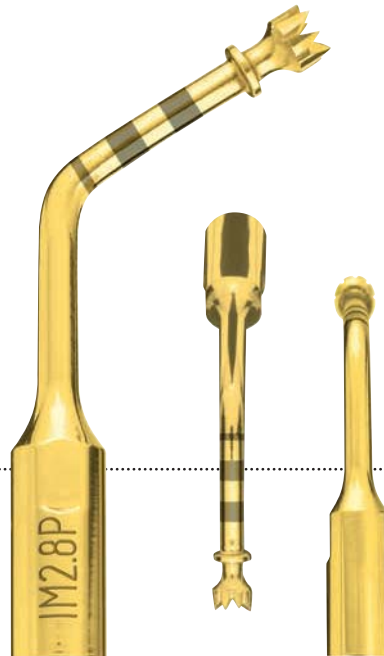
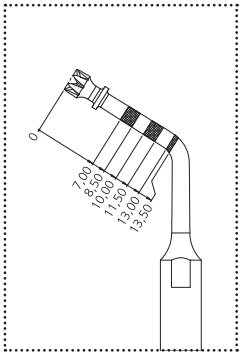

### → CUTTING ACTION

bone perforation

### → CLINICAL APPLICATION

to enlarge or to finalize the implant site preparation; insert with double irrigation to avoid overheating



# IM3A – IM3A-15

3 mm Ø implant site preparation insert

→ **CUTTING ACTION**  
bone perforation

→ **CLINICAL APPLICATION**  
to enlarge or to finalize the implant site preparation; insert with double irrigation to avoid overheating

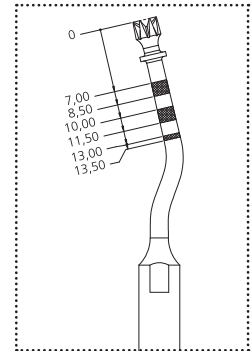
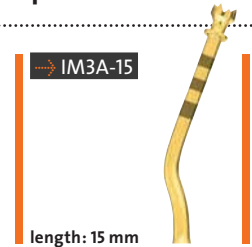

## 3 mm Ø implant site preparation insert

# IM3P – IM3P-15

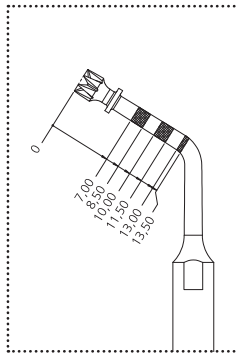

→ CUTTING ACTION  
bone perforation

→ CLINICAL APPLICATION  
to enlarge or to finalize the implant  
site preparation; insert with double  
irrigation to avoid overheating



→ CUTTING ACTION

bone perforation

→ CLINICAL APPLICATION

to enlarge or to finalize the implant site preparation; insert with double irrigation to avoid overheating

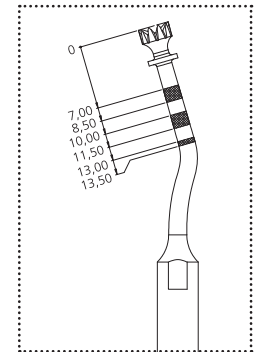

## 3.4 mm $\varnothing$ implant site preparation insert

IM3.4P

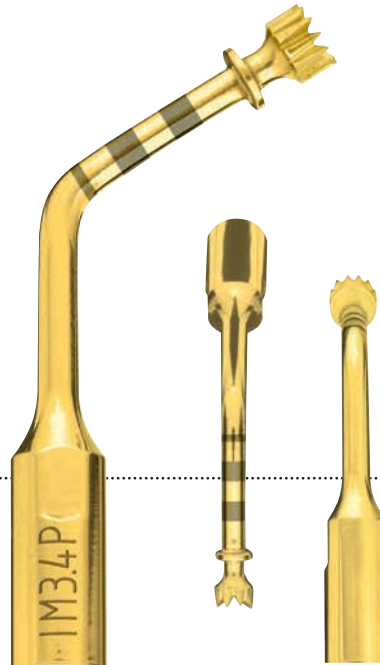
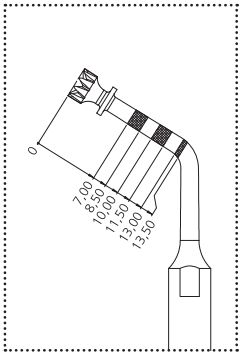

### → CUTTING ACTION

bone perforation

### → CLINICAL APPLICATION

to enlarge or to finalize the implant site preparation; insert with double irrigation to avoid overheating

→ CUTTING ACTION

bone perforation

→ CLINICAL APPLICATION

to finalize the implant site preparation; insert with double irrigation to avoid overheating

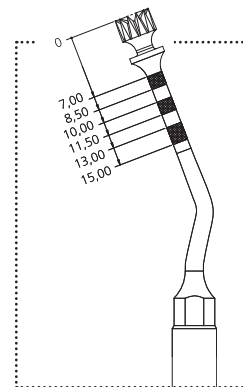



# 4 mm Ø implant site preparation insert

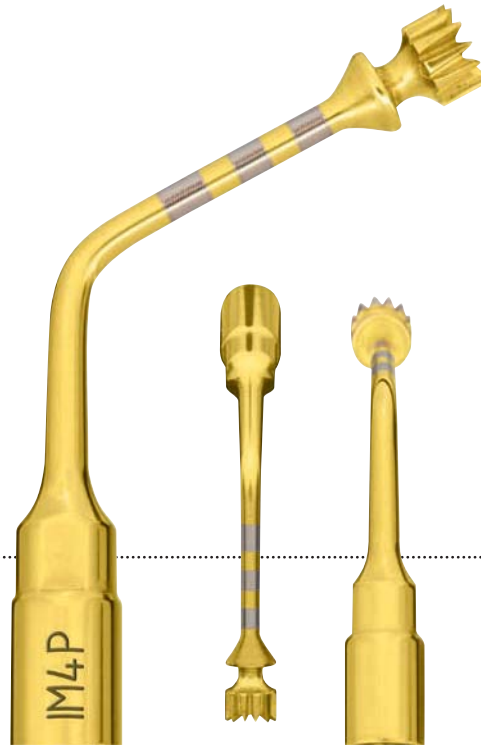
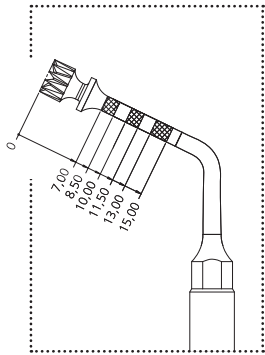

→ CUTTING ACTION  
bone perforation

→ CLINICAL APPLICATION  
to finalize the implant site  
preparation; insert with double  
irrigation to avoid overheating



→ CUTTING ACTION  
micrometric osteotomy

→ CLINICAL APPLICATION  
to optimize concentricity of  
implant site preparation  
between  $\varnothing 2$  and  $\varnothing 3$  mm

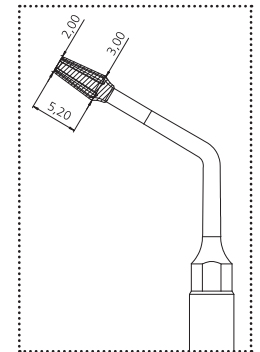
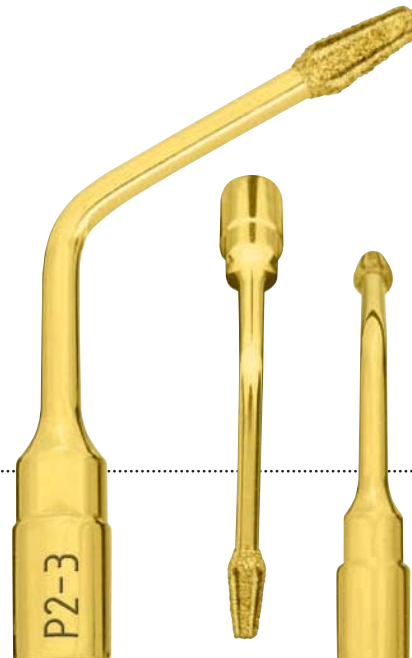

diamond grain size 150  $\mu$ m

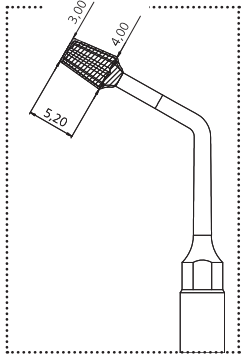

diamond grain size 150  $\mu$ m

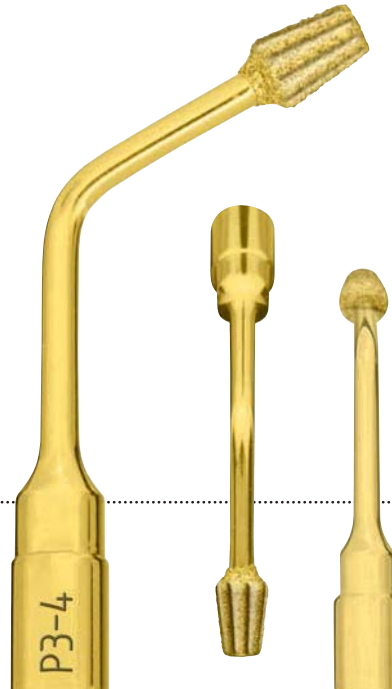

→ CUTTING ACTION  
micrometric osteotomy

→ CLINICAL APPLICATION  
to optimize concentricity of  
implant site preparation  
between  $\varnothing$  3 and  $\varnothing$  4 mm



# → BONE EXPANDERS

Dr. Sentineri's technique

## → DESCRIPTION

Only the initial part is threaded. When the smooth coronal part comes into contact with the corticalis, instead of penetrating into it, it displaces it, facilitating lateral expansion.

Usable with implantology micromotor or ratchet.

## → CLINICAL APPLICATION

- Technique for expanding the atrophic alveolar ridge
- Lateral bone condensation technique
- Alternative to the maxillary sinus elevation technique



## → AVAILABLE EXPANDERS

2.5 x 11.5

3.5 x 11.5

4.5 x 11.5

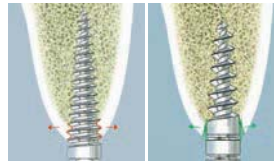

Conventional expander mectron expander



2.5 x 15



3.5 x 15



4.5 x 15

(Ø x length, in mm)

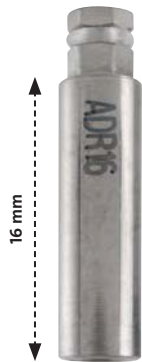

16 mm

→ ADR16

Long adapter  
for ratchet



7 mm

→ ADR7

Short adapter  
for ratchet



8 mm

→ ADM8

Adapter for  
micromotor



→ RATCHET

# → SINUS PHYSIOLIFT® II

## → DESCRIPTION

A new minimally invasive technique of maxillary sinus elevation by the crestal approach using screw elevators and hydrodynamic pressure.

## → CLINICAL APPLICATION

- Elevation of the sinus membrane with micrometric precision by means of hydrodynamic pressure
- Watertight sinus elevators CS1 or CS2 for hydrodynamic sinus lift
- Atraumatic technique not requiring the use of hammer and osteotome
- Implant site preparation using PIEZOSURGERY® – the new insert P2-3 SP allows to remove the sinus basal cortex with minimal risk of penetrating into sinus cavity due to its conical shape
- Multiple implant placement can be performed
- A flapless procedure can be performed in some cases

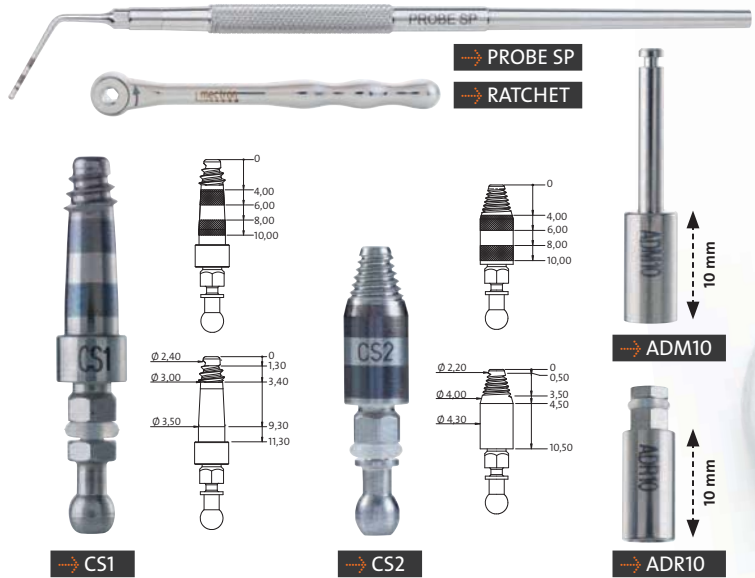

→ SINGLE IMPLANT SINUS LIFT

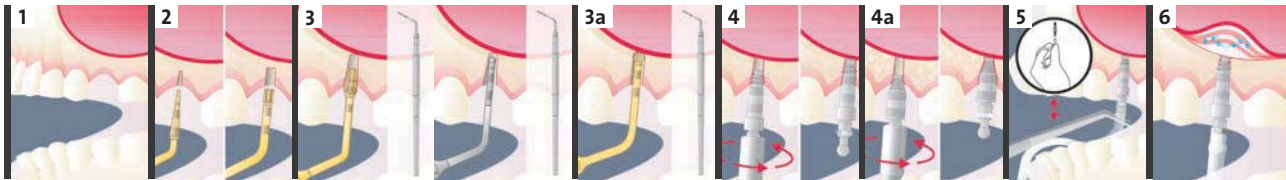



→ PHYSIOLIFTER



→ PLUG

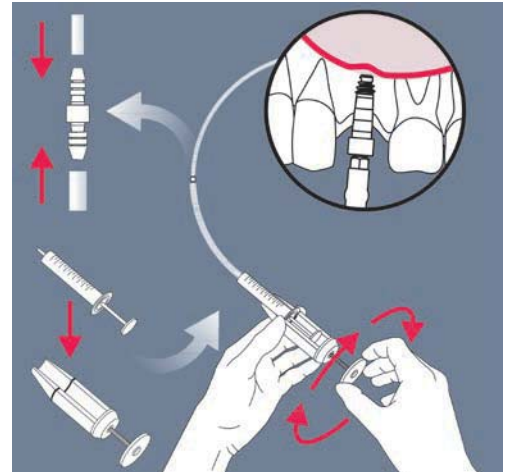

After preparation of the site with PIEZOSURGERY®, the CS1 or CS2 elevator is introduced, and the tube connected to a syringe containing 2 ml of physiological saline solution is then inserted in the CS1 or CS2. With the SINUS PHYSIOLIFT® II protocol, it is possible to elevate the Schneiderian membrane safely, controlling the pressure of the liquid by means of the attached Physiolifter device.

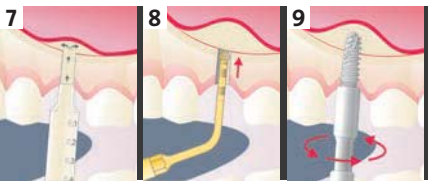

→ MULTIPLE IMPLANT SINUS LIFT



SINUS PHYSIOLIFT®

→ CUTTING ACTION

bone perforation

→ CLINICAL APPLICATION

initial osteotomy in Sinus Physiolift®  
technique

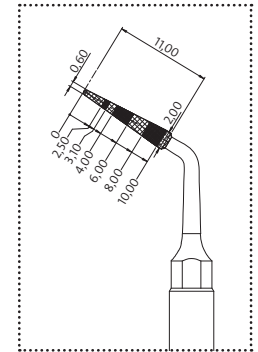



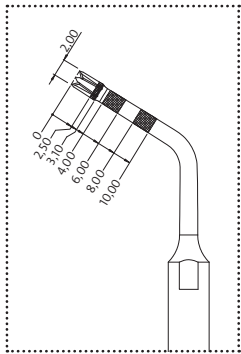

→ CUTTING ACTION

bone perforation

→ CLINICAL APPLICATION

osteotomy in Sinus Physiolift® technique



# → P2-3 SP

## implant site preparation insert

### → CUTTING ACTION

bone perforation

### → CLINICAL APPLICATION

removal of sinus basal cortex in  
Sinus Physiolift® procedure

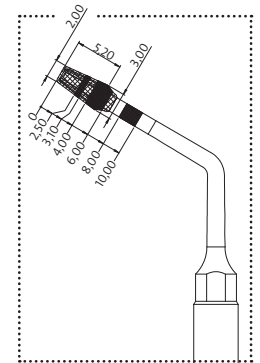

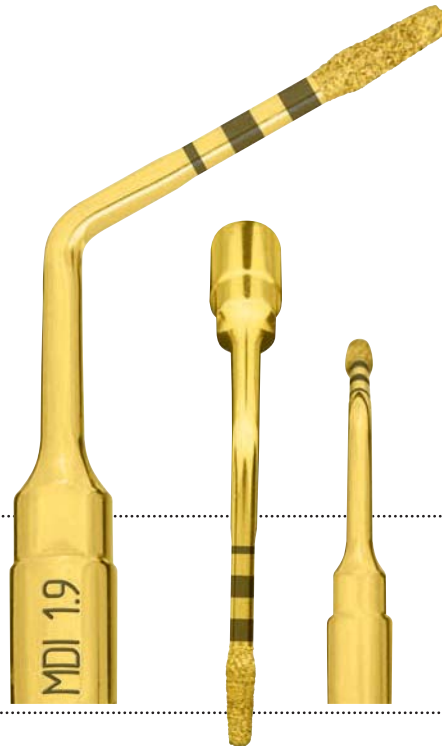
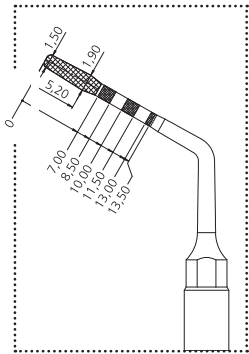

→ CUTTING ACTION

bone perforation

→ CLINICAL APPLICATION

osteotomy technique for mini implants  
site preparation



# → MDI 2.2

## mini dental implant insert

### → CUTTING ACTION

bone perforation

### → CLINICAL APPLICATION

osteotomy technique for mini implants  
site preparation

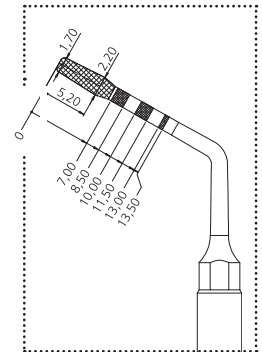
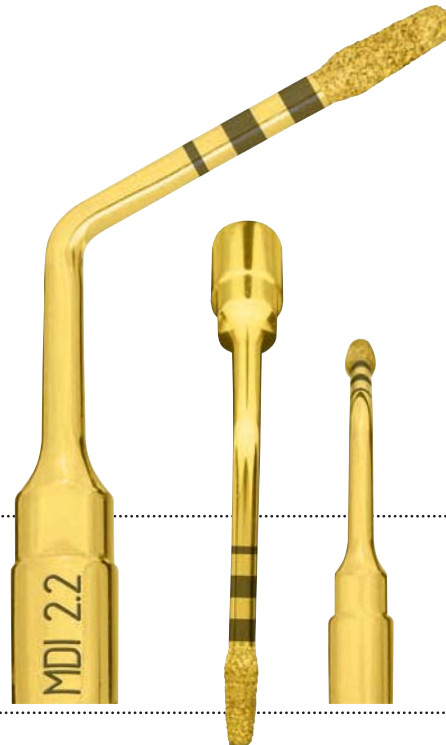

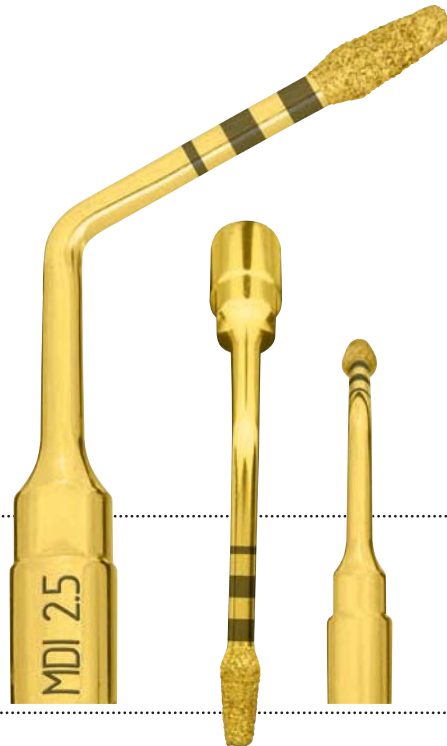
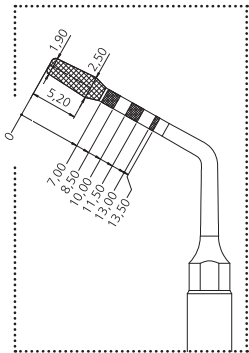

→ CUTTING ACTION

bone perforation

→ CLINICAL APPLICATION

osteotomy technique for mini implants  
site preparation

→ CUTTING ACTION

micrometric osteotomy (about 1 mm)

→ CLINICAL APPLICATION

to finalize the osteotomy in proximity of soft tissue (for example: sinus membrane, vessel, alveolar nerve)

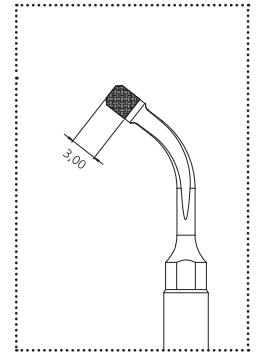
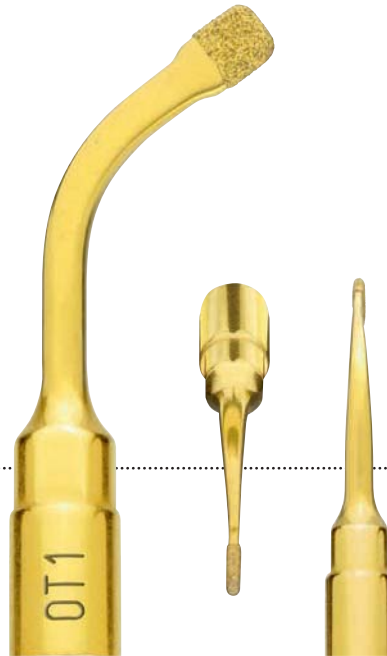

diamond grain size 91 µm

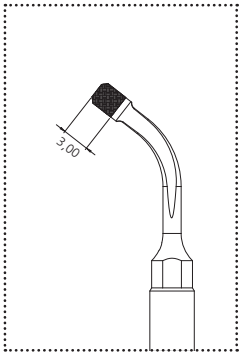

diamond grain size 126  $\mu\text{m}$

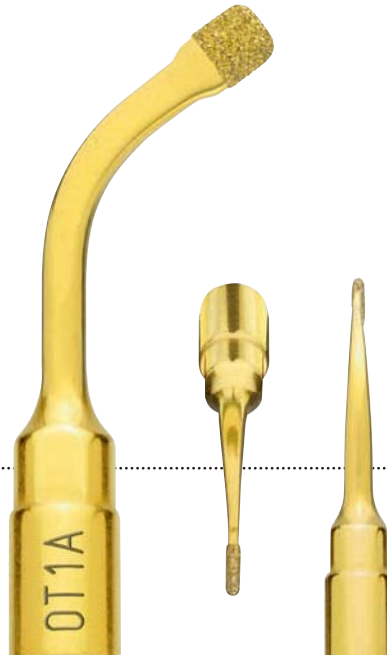

## → CUTTING ACTION

micrometric osteotomy (about 1 mm)

## → CLINICAL APPLICATION

to finalize the osteotomy in proximity of soft tissue (for example: sinus membrane, vessel, alveolar nerve)

→ CUTTING ACTION

osteotomy

→ CLINICAL APPLICATION

osteotome of great precision  
in anatomically thin structures  
(for example, ridge expansion,  
interdental corticotomies, non  
traumatic nasal spina)







→ CUTTING ACTION

osteotomy

→ CLINICAL APPLICATION

mandibular corticotomy, block  
harvesting, fragmenta osteotomy

→ CUTTING ACTION

micrometric osteotomy (about 1 mm)

→ CLINICAL APPLICATION

to correct pilot osteotomy axis, to finalize the implant site preparation close to the alveolar nerve; sinus crestal approach technique

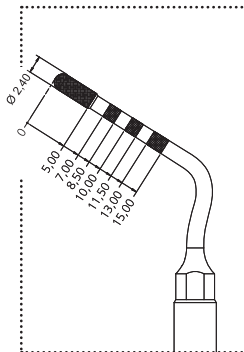

diamond grain size 151 µm

# osteoplasty and osteotomy insert

# → OT5 – OT5A – OT5B



→ CUTTING ACTION  
micrometric osteotomy or osteoplasty

→ CLINICAL APPLICATION  
non-traumatic, to finalize the osteotomy or osteoplasty on thin bone and/or near delicate anatomic structures

Ø 1.7 – diamond grain size 91 µm

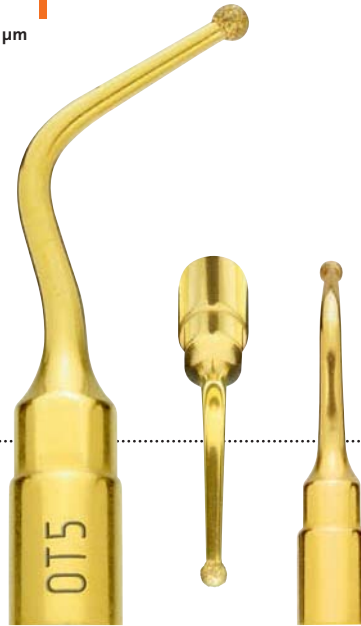

→ CUTTING ACTION

high effectiveness osteotomy

→ CLINICAL APPLICATION

osteotomy of large bone sections  
during maxillofacial surgery



# principal micro-saw 0.55 mm

# → OT7 – OT7A

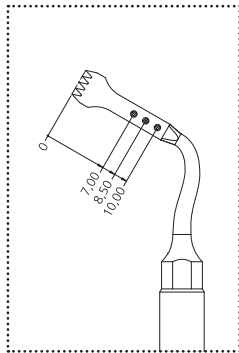

thickness 0.55 mm



→ CUTTING ACTION  
high effectiveness osteotomy

- CLINICAL APPLICATION
- all the osteotomy technique in maxilla and mandible
  - ridge expansion
  - corticotomy technique
  - bone block grafting

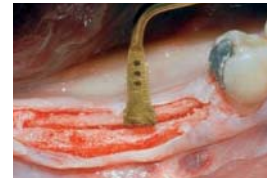

# → OT7S-4

special micro-saw 0.35 mm (4 teeth)

## → CUTTING ACTION

high effectiveness and precision  
osteotomy

## → CLINICAL APPLICATION

very thin osteotomy, corticotomy for  
orthodontic microsurgery technique,  
root separation in dental extraction  
technique and periodontal surgery

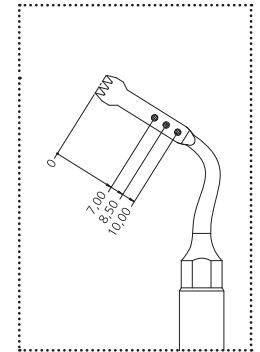

special micro-saw 0.35 mm (3 teeth)

→ OT7S-3

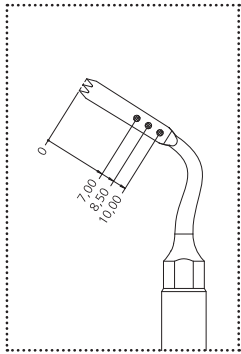

→ CUTTING ACTION

high precision osteotomy

→ CLINICAL APPLICATION

very thin and small osteotomy  
and corticotomy technique for  
orthodontic microsurgery, root  
fraction technique for dental  
extraction maneuver



# OT7-20

micro-saw, length 20 mm

## → CUTTING ACTION

high effectiveness osteotomy

## → CLINICAL APPLICATION

ridge expansion technique, bone block grafting (from chin/mandible ramus), Le Fort I osteotomy, bilateral sagittal split osteotomy



tight up this insert only with torque wrench K8

## → OT7-20 SET

The set consists of the insert OT7-20 and the torque wrench K8

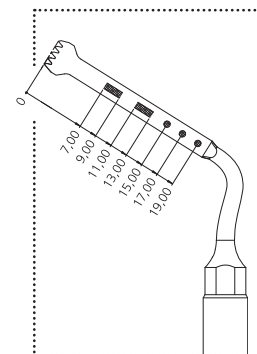

thickness 0.6 mm



angled micro-saw 0.6 mm

# OT8R – OT8L

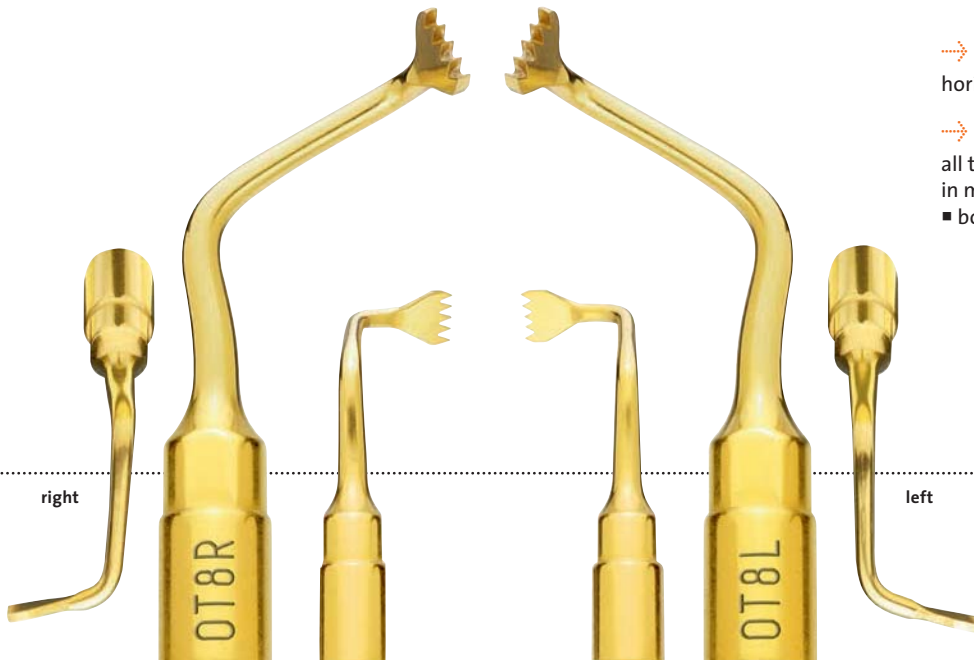

## → CUTTING ACTION

horizontal osteotomy

## → CLINICAL APPLICATION

all the osteotomy technique  
in maxilla and mandible

- bone block grafting



→ CUTTING ACTION

micrometric osteotomy or osteoplasty

→ CLINICAL APPLICATION

to finalize the osteotomy or osteoplasty near delicate anatomic structures; removal of the sinus basal cortex in Sinus Physiolift® procedure; insert with double irrigation to avoid overheating

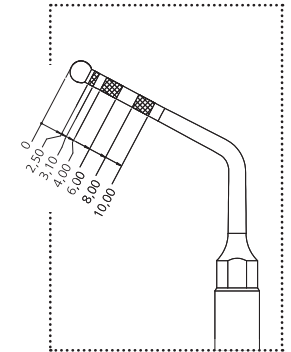

Ø 2.4 – diamond grain size 151 µm

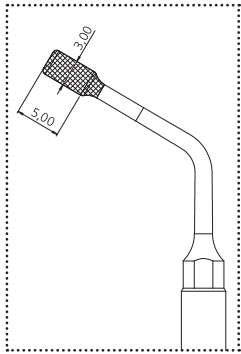

Ø 3.0 – diamond grain size 151 µm



→ **CUTTING ACTION**

micrometric osteotomy or osteoplasty

→ **CLINICAL APPLICATION**

removal of the sinus basal cortex and elevation of the sinus membrane



→ CUTTING ACTION

high effectiveness and precision osteotomy

→ CLINICAL APPLICATION

dedicated to the osteotomy techniques where the standard piezoelectric bone saws may have a difficult surgical approach

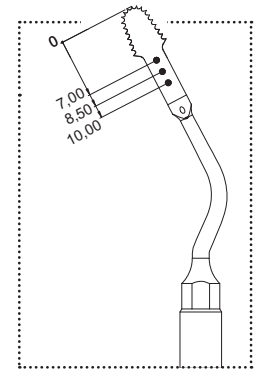

circular micro-saw 0.25 mm

→ OT12S

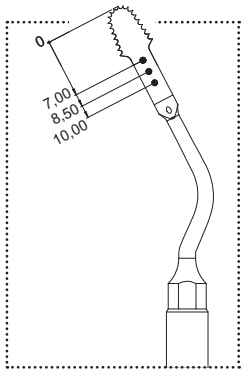

→ CUTTING ACTION

high effectiveness and precision  
osteotomy

→ CLINICAL APPLICATION

dedicated to the osteotomy  
techniques where the standard  
piezoelectric bone saws may have  
a difficult surgical approach

→ CUTTING ACTION

micrometric osteotomy or osteoplasty

→ CLINICAL APPLICATION

non-traumatic bone defect preparation  
in resective periodontal surgery

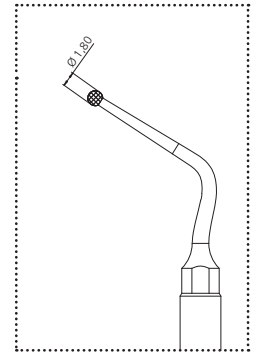

Ø 1.8 – diamond grain size 150 µm

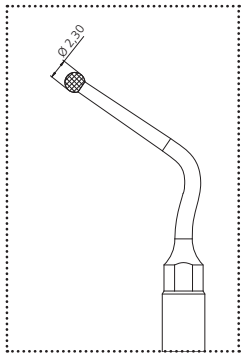

Ø 2.3 – diamond grain size 150 µm



→ **CUTTING ACTION**

micrometric osteotomy or osteoplasty

→ **CLINICAL APPLICATION**

non-traumatic bone defect preparation  
in resective periodontal surgery



→ CUTTING ACTION

high precision osteotomy

→ CLINICAL APPLICATION

to finalize the bone window osteotomy  
to gain access to the sinus membrane

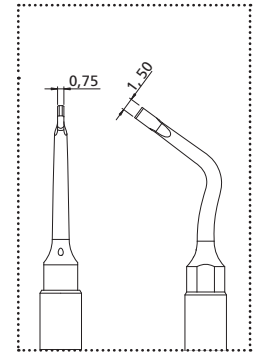



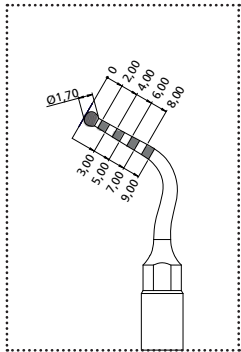

## → CUTTING ACTION

micrometric osteotomy or osteoplasty

## → CLINICAL APPLICATION

sinus floor reaching and safe bony ring removal during crestal sinus lift procedure (PIEZO-LIFT)



→ CUTTING ACTION

micrometric osteotomy or osteoplasty

→ CLINICAL APPLICATION

sinus floor consumption and initial membrane elevation during crestal sinus lift procedure (PIEZO-LIFT)

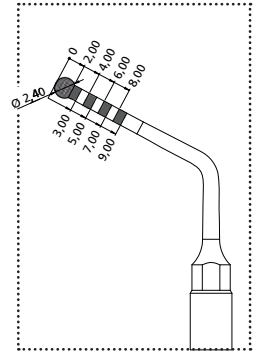

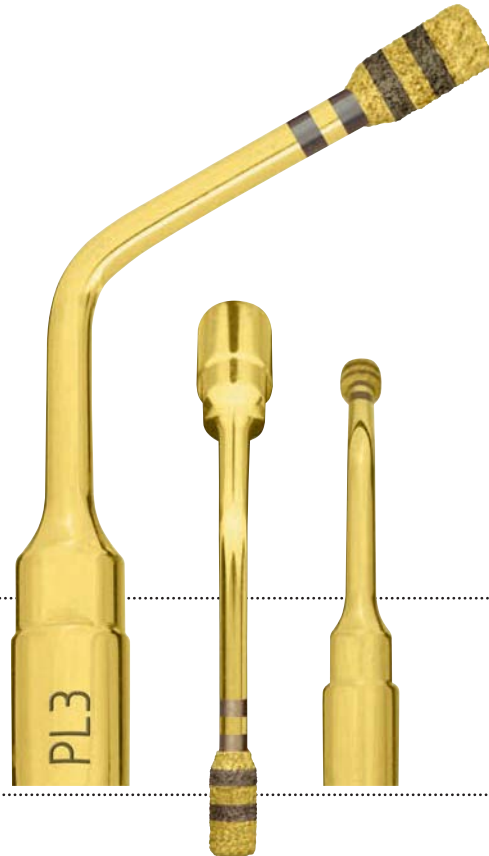
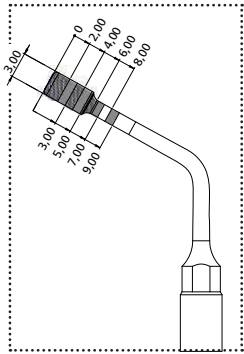

## → CUTTING ACTION

micrometric osteotomy or osteoplasty

## → CLINICAL APPLICATION

removal of the sinus basal cortex and elevation of the sinus membrane during crestal sinus lift procedure (PIEZO-LIFT)

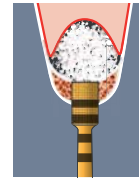

- CUTTING ACTION  
high efficiency bone osteoplasty
- CLINICAL APPLICATION  
bone remodelling and harvesting  
of bone chips





→ CUTTING ACTION

osteoplasty

→ CLINICAL APPLICATION

bone osteotomy, remodelling and  
removal of inflammatory tissue

# → OP3 – OP3A

principal osteoplasty insert

→ CUTTING ACTION

universal osteoplasty

→ CLINICAL APPLICATION

periodontal osteotomy, crown lengthening, bone chips harvesting, inflammatory tissue removal (cyst, etc.)



# crown lengthening file

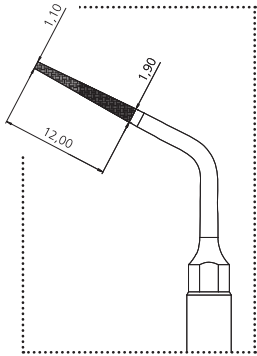

diamond grain size 126  $\mu\text{m}$

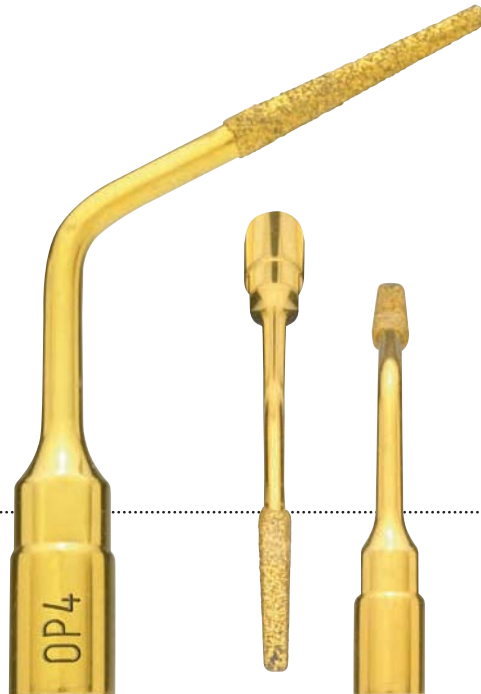

→ CUTTING ACTION  
micro-osteoplasty

→ CLINICAL APPLICATION  
interproximal osteoplasty  
and root planing



# → OP5 – OP5A

root debridement insert

→ CUTTING ACTION

micro-osteoplasty

→ CLINICAL APPLICATION

root debridement and root planing during resective and regenerative periodontal surgery



diamond grain size 90 µm

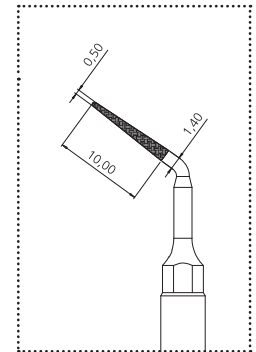

diamond grain size 30 µm

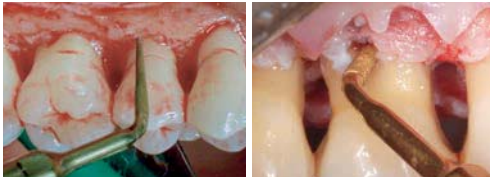



# micro-root-preparation

# → OP6 – OP6A



diamond grain size 30 µm

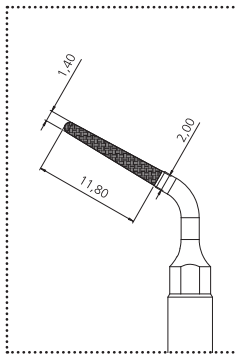

diamond grain size 126 µm



→ CUTTING ACTION  
micro-root preparation

→ CLINICAL APPLICATION  
root preparation in periodontal surgery



→ CUTTING ACTION

micro-osteoplasty

→ CLINICAL APPLICATION

peri-apical maxillary bone  
osteotomy access, inflammatory  
tissue removal



# crown lengthening file / perio file

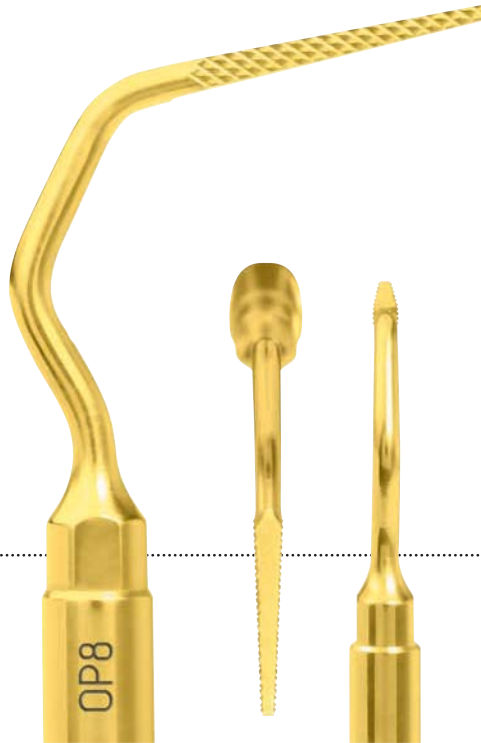
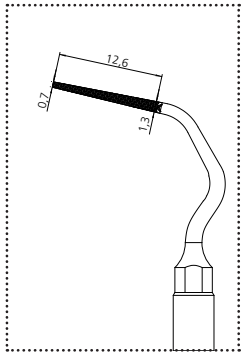

→ CUTTING ACTION  
micro-osteoplasty

→ CLINICAL APPLICATION  
Interproximal osteoplasty without  
damaging adjacent root surfaces



\*only available for PIEZOSURGERY® 3, PIEZOSURGERY® touch and PIEZOSURGERY® white

→ CUTTING ACTION  
micro-osteoplasty

→ CLINICAL APPLICATION  
Interproximal osteoplasty without  
damaging adjacent root surfaces

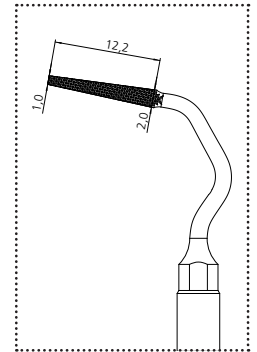
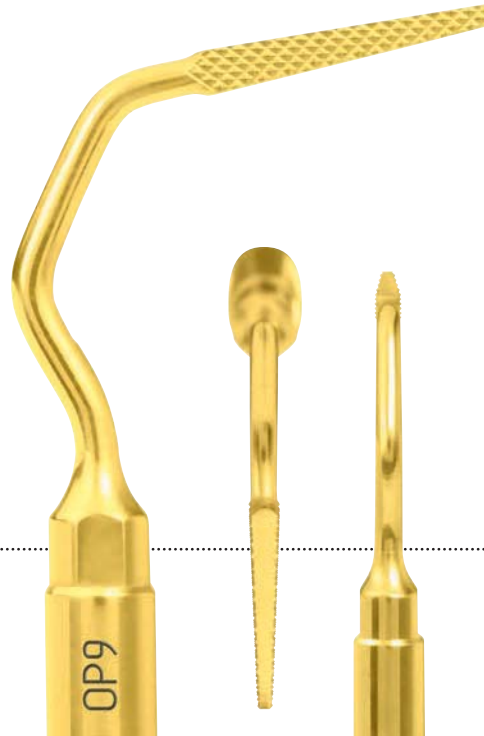

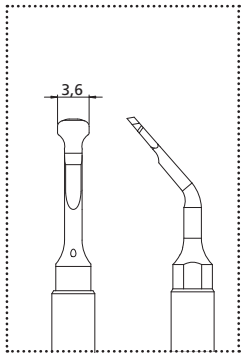

## → CUTTING ACTION

universal osteoplasty

## → CLINICAL APPLICATION

sinus vestibular wall consumption to gain the membrane access; bone chips harvesting, inflammatory tissue removal



→ CUTTING ACTION

schneiderian membrane  
separation from bony walls

→ CLINICAL APPLICATION

separation of the sinus membrane,  
2 mm around the frame of bony window

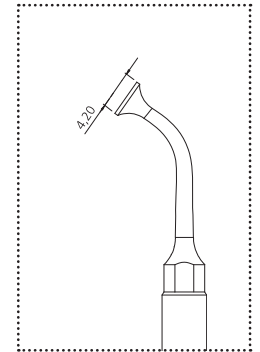

sinus membrane separator angled at 100°



→ CUTTING ACTION

non-cutting elevator of the  
sinus membrane

→ CLINICAL APPLICATION

separation of the sinus membrane  
in internal zones



→ CUTTING ACTION

non-cutting elevator of the  
sinus membrane

→ CLINICAL APPLICATION

separation of the sinus membrane  
in internal zones





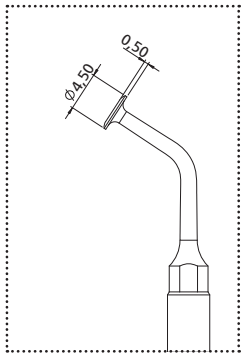

→ CUTTING ACTION  
sinus membrane separator

→ CLINICAL APPLICATION  
sinus membrane separation from  
the bony window margins



- **CUTTING ACTION**  
elevator to cut Sharpey's fibers  
from the endosteum
- **CLINICAL APPLICATION**  
sinus membrane elevation  
from the sinus floor

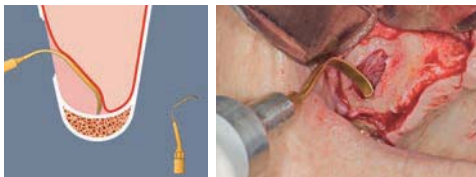
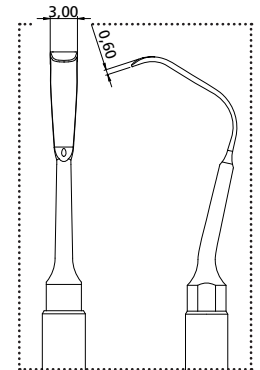

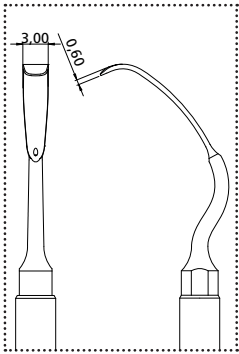

→ CUTTING ACTION

elevator to cut Sharpey's fibers from the endosteum

→ CLINICAL APPLICATION

sinus membrane elevation from the palatal wall

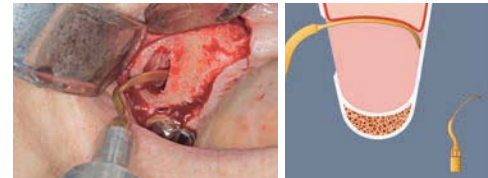

→ CUTTING ACTION  
periosteum elevator

→ CLINICAL APPLICATION  
subperiosteal preparation

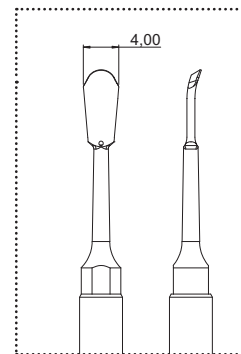

# piezoelectric raspatory, 5 mm width

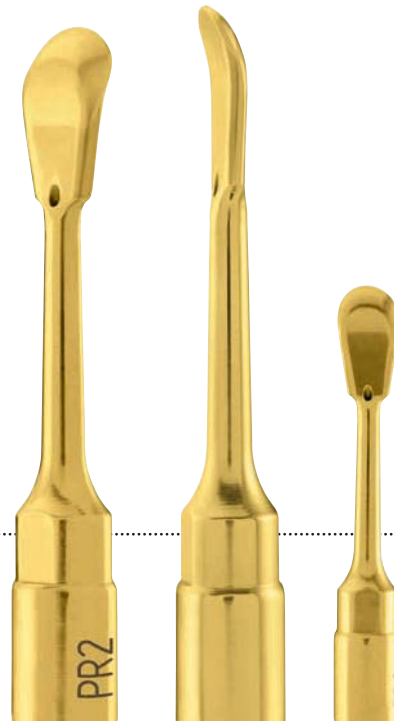
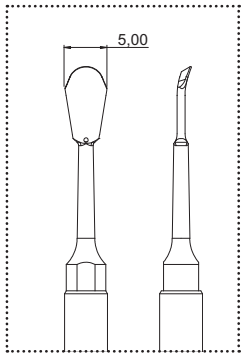

→ CUTTING ACTION  
periosteum elevator

→ CLINICAL APPLICATION  
subperiosteal preparation



→ CUTTING ACTION  
efficient canal cleaning

→ CLINICAL APPLICATION  
apical root debridement

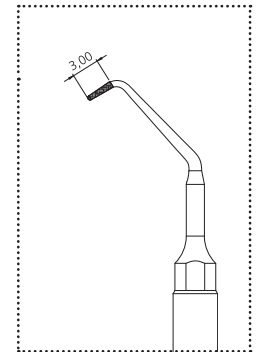

diamond grain size 30 µm

# smooth endo apical debrider 3 mm

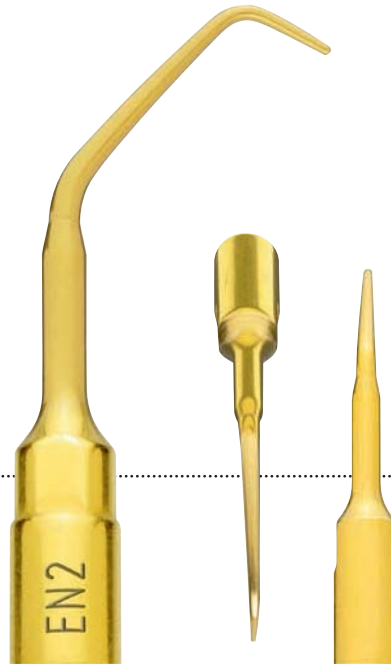

## → CUTTING ACTION

gentle canal cleaning

## → CLINICAL APPLICATION

gentle apical root debridement



→ CUTTING ACTION  
efficient canal cleaning

→ CLINICAL APPLICATION  
apical root debridement

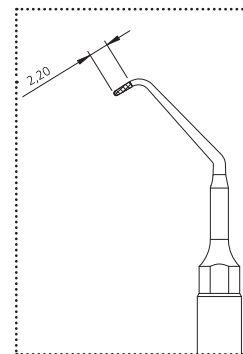
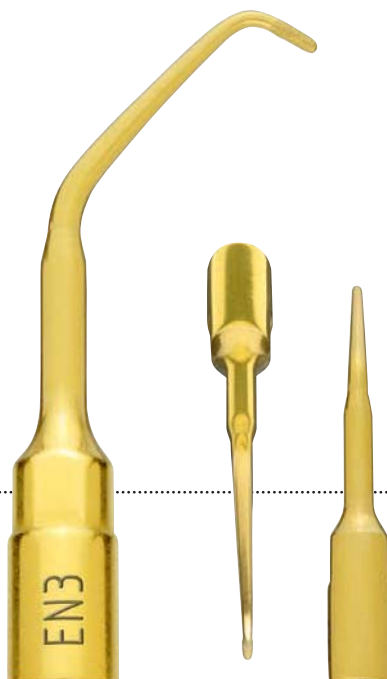

diamond grain size 30 µm



# smooth endo apical debrider 2.2 mm



## → CUTTING ACTION

gentle canal cleaning

## → CLINICAL APPLICATION

gentle apical root debridement

→ CUTTING ACTION  
efficient canal cleaning

→ CLINICAL APPLICATION  
apical root debridement

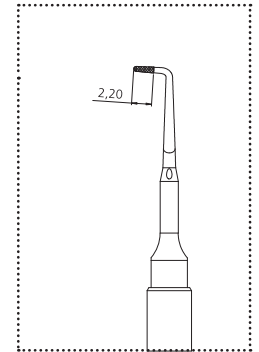
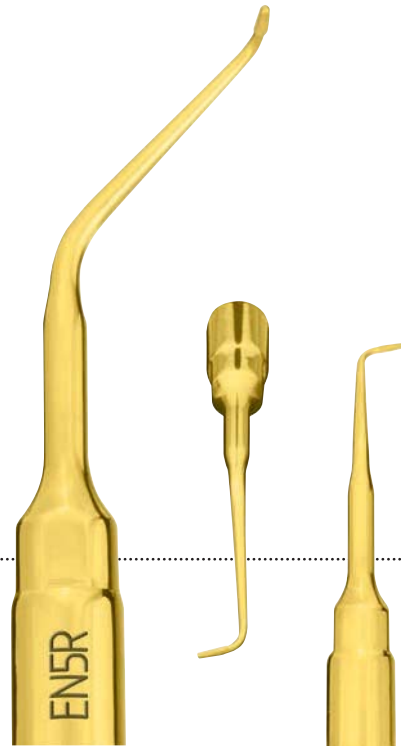

diamond grain size 30 µm

# left angled, diamond-coated endo apical debrider 2.2 mm

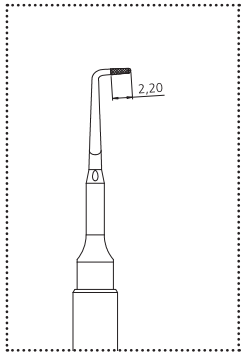

diamond grain size 30 µm

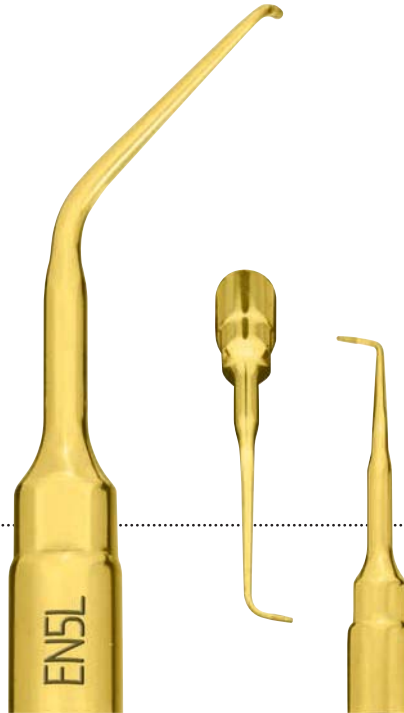

→ CUTTING ACTION  
efficient canal cleaning

→ CLINICAL APPLICATION  
apical root debridement

→ CUTTING ACTION  
efficient canal cleaning

→ CLINICAL APPLICATION  
apical root debridement

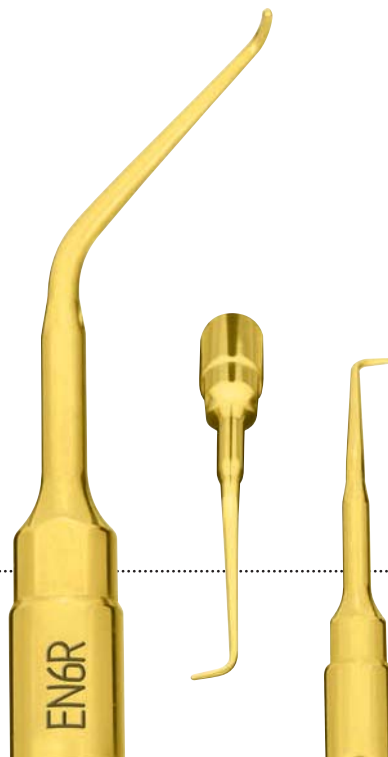

# left angled, smooth endo apical debrider 2.2 mm

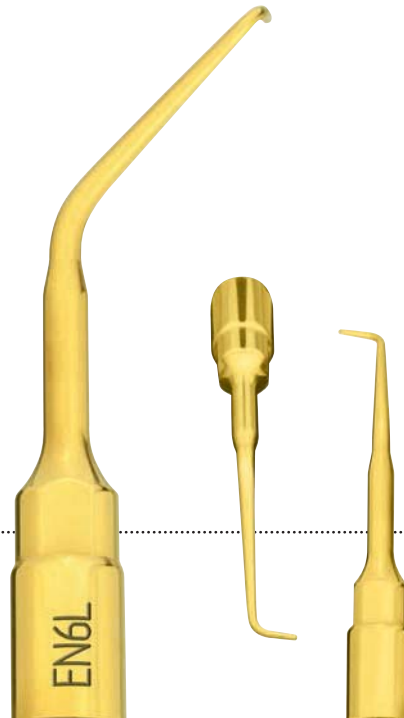

## → CUTTING ACTION

efficient canal cleaning

## → CLINICAL APPLICATION

apical root debridement

→ CUTTING ACTION

delicate osteotomy

→ CLINICAL APPLICATION

to cut off the ankylosis, root fraction techniques



# angled extraction scalpel

# EX2 – EX3

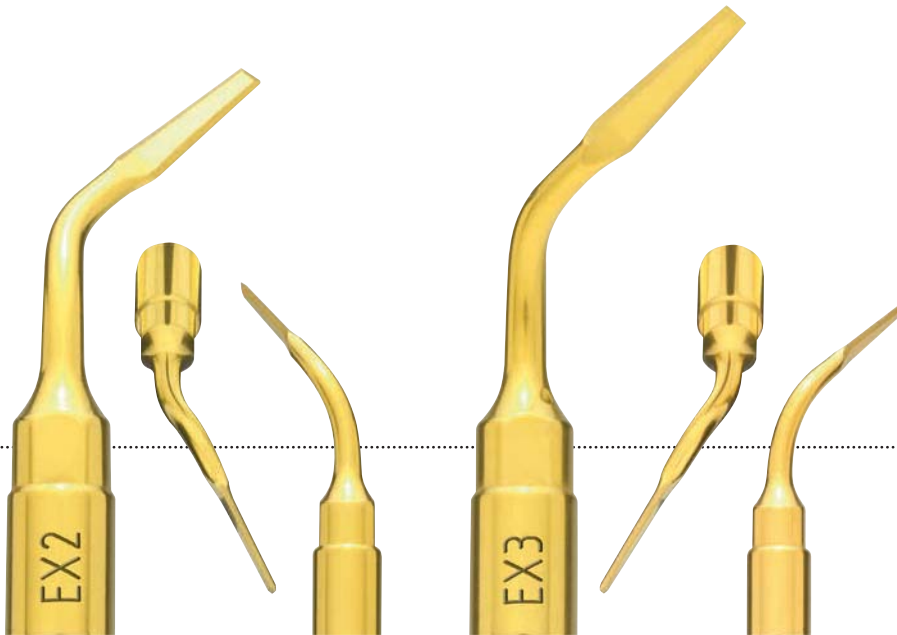

→ CUTTING ACTION  
micrometric osteotomy

→ CLINICAL APPLICATION  
analogue to EX1 in the posterior regions



# EXP3-R – EXP3-L

explantations

→ CUTTING ACTION  
peri-implant osteotomy

→ CLINICAL APPLICATION  
explantations

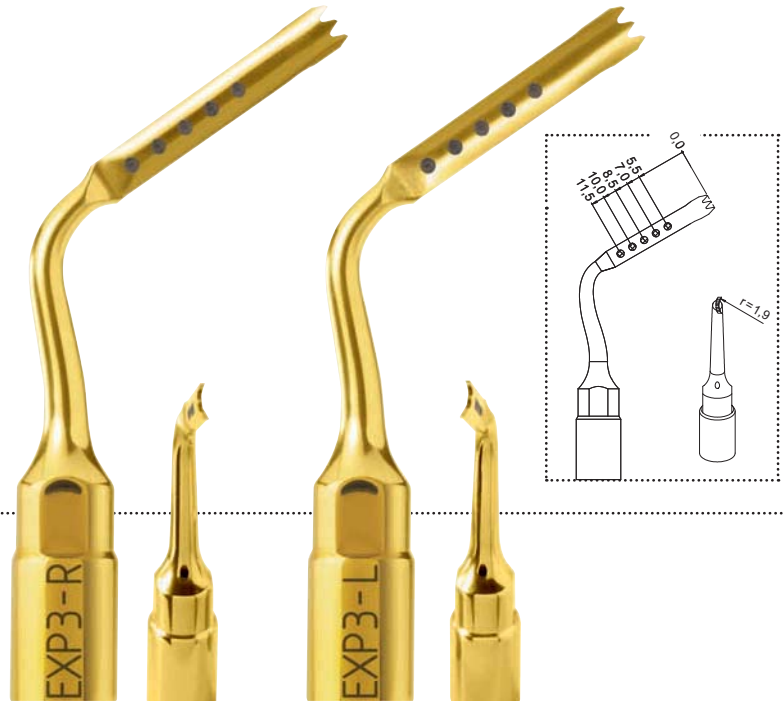



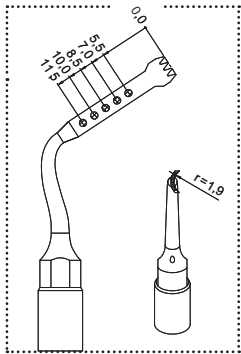

→ CUTTING ACTION  
peri-implant osteotomy

→ CLINICAL APPLICATION  
explantations



→ CUTTING ACTION  
gentle scaling

→ CLINICAL APPLICATION  
root scaling

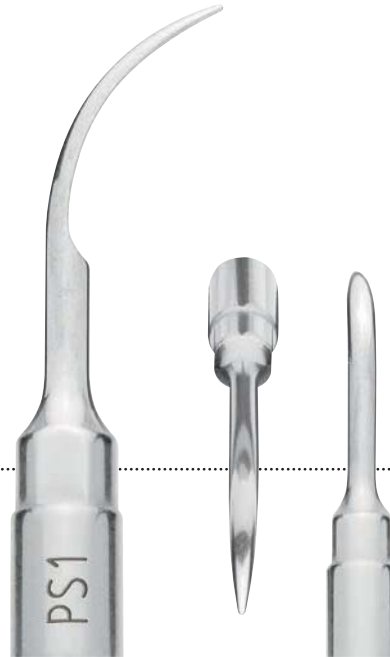

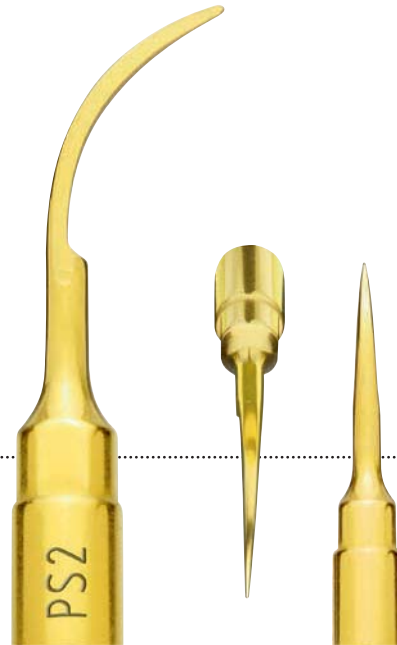

→ CUTTING ACTION

powerful scaling

→ CLINICAL APPLICATION

scaling and inflammatory tissue removal  
fractured root apex extraction



→ CUTTING ACTION  
gentle scaling

→ CLINICAL APPLICATION  
root scaling





→ CUTTING ACTION  
root surface micro-smoothing

→ CLINICAL APPLICATION  
root planing

→ CUTTING ACTION

root surface micro-smoothing

→ CLINICAL APPLICATION

gentle subgingival concretions removal

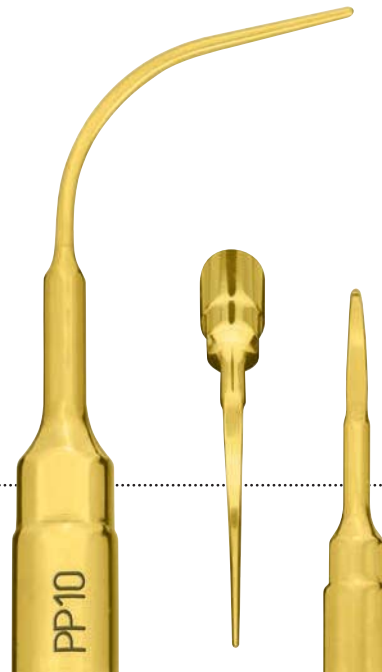

left and right angled, gentle perio anatomic insert

# PP11 – PP12

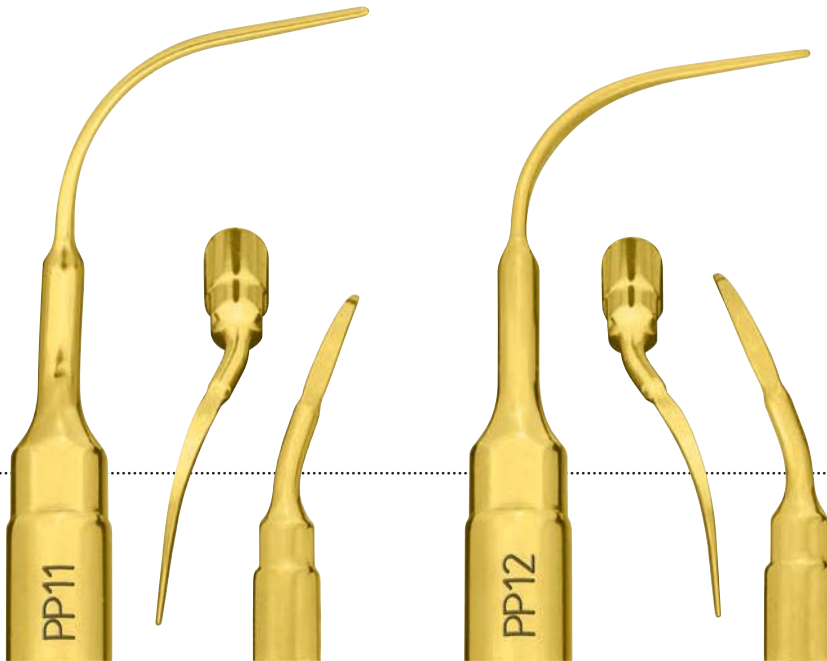

- CUTTING ACTION  
root surface micro-smoothing
- CLINICAL APPLICATION  
gentle subgingival concretions removal



- **CUTTING ACTION**  
gentle and safe cleaning action of the implant surface
- **CLINICAL APPLICATION**  
efficient and soft cleaning of implants and restorations



### → IMPLANT CLEANING SET P

The set consists of a tip holder ICP and 5 tips IC1

→ ICP  
tip holder ICP

→ IC1  
implant cleaning tip IC1 can be easily tightened without special tools and is fully autoclavable



preparation and finishing of subgingival margins

# → CROWN PREP TIPS



→ CUTTING ACTION

micro-smoothing

→ CLINICAL APPLICATION

ultrasonic finishing of the cervical margin

→ DYNAMOMETRIC  
WRENCH K7



→ KEY AB1



→ LENGTH 10 MM → DIAMOND COATING

diameter	D120	D90	D60
1.2 mm		TA12D90	TA12D60
1.4 mm	TA14D120	TA14D90	TA14D60
1.6 mm	TA16D120	TA16D90	TA16D60

→ CROWN  
PREP TIP TA14D60

# ENZYMEC

enzymatic detergent

- enzymatic solution for efficient removal of organic residue
- specifically dedicated to the “clean” function of all PIEZOSURGERY® devices
- works perfectly in ultrasonic cleaning tanks
- easy handling thanks to the dosage measuring cap

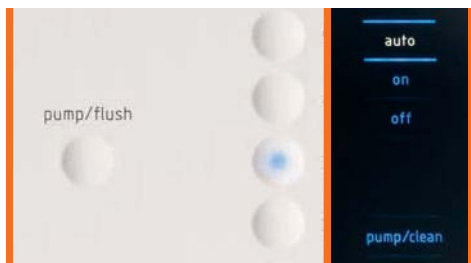

.....

.....

.....

## → PIEZOSURGERY® – MORE THAN 20 YEARS OF SUCCESSFUL SCIENTIFIC RESEARCH



### → METHOD PIEZOSURGERY®: EVIDENCE-BASED

With over 20 years of successful clinical research, the original PIEZOSURGERY® method is the only one supported by more than 250 clinical and scientific studies. An updated list of publications can be found at [www.mectron.com](http://www.mectron.com). Scientific Abstracts are also available for download.

# → EXPERIENCE EDUCATION – MECTRON IS COMMITTED TO ENSURING YOU GET THE BEST KNOWLEDGE OF PIEZOSURGERY® METHOD.

PIEZOSURGERY has caused a paradigm shift in osseous surgery and has become the new standard of care in oral and periodontal surgery. In addition to its revolutionary technology, its unique level of quality and its optimal ergonomic features, there is yet one more important factor to success with PIEZOSURGERY® technology: you.



## → PIEZOSURGERY.MECTRON.COM

Visit our website at piezosurgery.mectron.com and discover the latest surgical videos and clinical animations allowing an easy orientation about the possibilities PIEZOSURGERY® is offering.

## → WWW.PIEZO-NET.ORG

PIEZOSURGERY® Network is an international community of mectron PIEZOSURGERY® users interested to share their experiences and knowledge. The website presents clinical cases and informs about the latest clinical and technical developments.

## → WWW.MECTRON.COM/EDUCATION

On www.mectron.com we offer you even more seminars: In the section courses and workshops you will find different seminars on PIEZOSURGERY® in English. Please contact your mectron partner for the courses in your local language – you will find the contact address in the dealer list on our website.

# SPARE PARTS



handpiece, complete with cord



handpiece holder with LED-handpiece

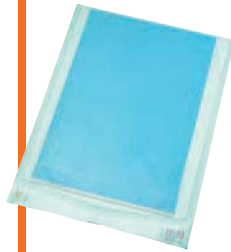

protection foils



PIEZOSURGERY® insert box



torque wrench K8

## → COMMON SPARE PARTS

→ ITEM/REFERENCE NUMBER	
surgical tray	04610004
torque wrench K8	02900109
irrigation set	03230006
PIEZOSURGERY® insert box	02900111
insert tray	02900037
bone expander tray	02900107
implant insert tray	02900108
bag support rod	01380002

## → PIEZOSURGERY® *touch*

## → PIEZOSURGERY® *white*

→ ITEM/REFERENCE NUMBER	
LED-handpiece, complete with cord	03120134
handpiece, complete with cord (compatible with PS white)	03120217
handpiece holder	02900105
mobile handpiece holder	03110015
handpiece LED-cone	03020158
handpiece metal cone	03020171
kit of 8 tubes for pump	02900104
bone grafting kit (liquid flow rate reducer)	02900106
protection foils (pack of 10 sterile pieces)	03230012
footswitch (PS <i>touch</i> )	02900102
footswitch (PS <i>white</i> )	02900114
suitcase (PS <i>touch</i> and PS <i>white</i> )	04440006

## → PIEZOSURGERY® I, II AND 3

→ ITEM/REFERENCE NUMBER	
handpiece, complete with cord	03120023
handpiece holder (PSII + 3)	02900040
kit of 8 tubes for pump (PSII + 3) (handpiece cord with metal connector)	02900039
kit of 8 tubes for pump (PSII + 3) (handpiece cord with plastic connector)	02900104
tube-tube connector	00680027
footswitch (PSI + II)	02900020
footswitch (PS3)	02900078
peristaltic pump	03210006

## → WARNINGS

### → DIAMOND-COATED INSERTS

When the diamond chips wear out a reduction in cutting capacity and a consequent increase in temperature may occur. Use these inserts for a maximum of ten applications.

### → CUTTING INSERTS

When the nitriding wears out the cutting edge loses efficiency and a re-sharpening is unadvisable due to its limited life-span.

### → MEMBRANE SEPARATORS

For a greater life-span it is recommended to use it on low power.  
High power can be useful if there are residual bony edges to be removed.

# REFERENCE NUMBERS

## → ITEM/REFERENCE NUMBER

basic kit	01520001
osteotomy kit	01520010
sinus lift lateral kit	01520023
piezo lift kit	01520024
sinus lift kit	01520002
implant prep kit	01520008
implant prep kit pro	01520011
implant prep kit starter	01520017
mini implant prep kit	01520016
extraction kit	01520003
explantation kit	01520021
periodontal kit	01520004
resective perio kit	01520022
retro surgical kit	01520005
bone expander kit	03770001
bone expander kit pro	03770002
bone expander kit pro s	03770005
sinus physioltift® II kit basic	03770011
sinus physioltift® II kit pro	03770012
insert IM15	03510019
PIN IM1	03740002
PIN IM15	03740007
PIN 2-2.4	03740003
PIN 2-3	03740001
insert IM1 AL	03510010
PIN IM1 AL	03740004
PIN 2-2.4 AL	03740005

## → ITEM/REFERENCE NUMBER

PIN 2-3 AL	03740006
insert IM2A	03510001
insert IM2A-15	03510015
insert IM2P	03510002
insert IM2P-15	03510016
insert IM2.8A	03510025
insert IM2.8P	03510026
insert IM3A	03510003
insert IM3A-15	03510017
insert IM3P	03510004
insert IM3P-15	03510018
insert IM3.4A	03510027
insert IM3.4P	03510028
insert IM4A	03510005
insert IM4P	03510006
insert P2-3	03510020
insert P3-4	03510021
expander 2.5 x 11.5	03780001
expander 3.5 x 11.5	03780003
expander 4.5 x 11.5	03780005
expander 2.5 x 15	03780002
expander 3.5 x 15	03780004
expander 4.5 x 15	03780006
ADM8	03790001
ADR7	03790002
ADR16	03790003
ratchet	02270005

## → ITEM/REFERENCE NUMBER

crestal sinus elevator CS1	03920001
crestal sinus elevator CS2	03920002
insert IM1 SP	03510011
insert IM2 SP	03510022
insert P2-3 SP	03510024
physiolifter	02900097
PROBE SP	03920003
ADM10	03790004
ADR10	03790005
silicone tube with tube-tube connector	02900098
complete sealed tube	02900099
insert tray physioltift® (small)	02900100
insert tray physioltift® (large)	02900101
insert MDI 1.9	03510012
insert MDI 2.2	03510013
insert MDI 2.5	03510014
insert OT1	03370001
insert OT1A	03370008
insert OT2	03370002
insert OT3	03370003
insert OT4	03370004
insert OT5	03370005
insert OT5A	03370009
insert OT5B	03370010
insert OT6	03370006
insert OT7	03370007
insert OT7A	03370011



→ ITEM/REFERENCE NUMBER

insert OT7S-4	03370014
insert OT7S-3	03370015
insert OT7-20	03370017
OT7-20 set (OT7-20 and K8)	02900103
insert OT8R	03370012
insert OT8L	03370013
insert OT9	03370016
insert OT11	03370019
insert OT12	03370020
insert OT12S	03370021
insert OT13	03370022
insert OT14	03370023
insert SLO-H	03370025
insert PL1	03370026
insert PL2	03370027
insert PL3	03370028
insert OP1	03380001
insert OP2	03380002
insert OP3	03380003
insert OP3A	03380011
insert OP4	03380004
insert OP5	03380005
insert OP5A	03380012
insert OP6	03380006
insert OP6A	03380010
insert OP7	03380007
insert OP8	03380008

→ ITEM/REFERENCE NUMBER

insert OP9	03380009
insert SLC	03380013
insert EL1	03390001
insert EL2	03390002
insert EL3	03390003
insert SLS	03390006
insert SLE1	03390007
insert SLE2	03390008
insert PR1	03390004
insert PR2	03390005
insert EN1	02170001
insert EN2	02170002
insert EN3	02170005
insert EN4	02170006
insert EN5R	02170007
insert EN5L	02170008
insert EN6R	02170009
insert EN6L	02170010
insert EX1	03400001
insert EX2	03400002
insert EX3	03400003
insert EXP3-R	03400004
insert EXP3-L	03400005
insert EXP4-R	03400006
insert EXP4-L	03400007
insert PS1	03180001
insert PS2	03180003

→ ITEM/REFERENCE NUMBER

insert PS6	03180005
insert PP1	03180002
insert PP10	03180006
insert PP11	03180007
insert PP12	03180008
tipholder ICP	03570003
tip IC1 (5 pieces)	02900112
implant cleaning set P (ICP and 5 x IC1)	01520020
crown prep kit PS (DB2, AB1 and K7)	02160010
tipholder DB2	03570002
key AB1	03580001
dynamometric wrench K7	02900081
crown prep tip TA12D60	03590001
crown prep tip TA14D60	03590002
crown prep tip TA16D60	03590003
crown prep tip TA12D90	03590004
crown prep tip TA14D90	03590005
crown prep tip TA16D90	03590006
crown prep tip TA14D120	03590007
crown prep tip TA16D120	03590008
Enzymec bottle (1 liter)	03900001
Enzymec 4-bottle pac (4 liter)	03900002

# → APPROPRIATE SETTINGS FOR THE INSERTS



## → PIEZOSURGERY® touch → PIEZOSURGERY® white

### → INSERT FUNCTION

#### IMPLANT PREP

INSERT	FUNCTION
IM1S	special*
IM1 AL	implant
IM2A	implant
IM2A-15	implant
IM2P	implant
IM2P-15	implant
IM2.8A	implant
IM2.8P	implant
IM3A	implant
IM3A -15	implant
IM3P	implant
IM3P-15	implant
IM3.4A	implant
IM3.4P	implant
IM4A	implant
IM4P	implant
P2-3	implant
P3-4	implant
IM1 SP	implant
IM2 SP	implant
P2-3 SP	implant

### → INSERT FUNCTION

#### OSTEOTOMY

INSERT	FUNCTION
OT1	cancellous / cortical
OT1A	cancellous / cortical
OT2	cancellous / cortical
OT3	cancellous / cortical
OT4	cancellous / cortical
OT5	cancellous / cortical
OT5A	cancellous / cortical
OT5B	cancellous / cortical
OT6	cancellous / cortical
OT7	cancellous / cortical
OT7A	cancellous / cortical
OT7S-3	special*
OT7S-4	special*
OT7-20	cancellous / cortical
OT8L	cancellous / cortical
OT8R	cancellous / cortical
OT9	cancellous / cortical
OT11	cancellous / cortical
OT12	cancellous / cortical
OT12S	special*
OT13	cancellous / cortical
OT14	cancellous / cortical
SLO-H	cancellous / cortical
PL1	cancellous / cortical
PL2	cancellous / cortical
PL3	cancellous / cortical

#### OSTEOPLASTY

INSERT	FUNCTION
OP1	cancellous / cortical
OP2	cancellous / cortical
OP3	cancellous / cortical
OP3A	cancellous / cortical
OP4	cancellous / cortical
OP5	perio
OP5A	perio / special
OP6	perio
OP6A	perio
OP7	cancellous / cortical
OP8	perio / special
OP9	cancellous / cortical
SIC	cancellous / cortical

#### MINI IMPLANT PREP

INSERT	FUNCTION
MDI 1.9	implant
MDI 2.2	implant
MDI 2.5	implant

### → INSERT FUNCTION

#### SINUS MEMBRANE ELEVATION

INSERT	FUNCTION
EL1	endo*
EL2	endo*
EL3	endo*
SLS	special*
SLE1	special*
SLE2	special*

#### PERIOSTEUM

INSERT	FUNCTION
PR1	cancellous / cortical
PR2	cancellous / cortical

#### ENDO RETRO

INSERT	FUNCTION
EN1	endo*
EN2	endo*
EN3	endo*
EN4	endo*
EN5R	endo*
EN5L	endo*
EN6R	endo*
EN6L	endo*

#### EXTRACTION

INSERT	FUNCTION
EX1	cancellous / cortical
EX2	cancellous / cortical
EX3	cancellous / cortical

#### EXPLANATION

INSERT	FUNCTION
EXP3-R	special / cancellous / cortical
EXP3-L	special / cancellous / cortical
EXP4-R	special / cancellous / cortical
EXP4-L	special / cancellous / cortical

#### PERIO

INSERT	FUNCTION
PP1	perio
PS1	perio
PS2	perio
PS6	perio
PP10	perio
PP11	perio
PP12	perio

#### IMPLANT CLEANING

INSERT	FUNCTION
ICP + IC1	endo / perio

#### RESTORATIVE

INSERT	FUNCTION
DB2	perio special



## PIEZOSURGERY® 3

→ INSERT MODE POWER

### IMPLANT PREP

	BONE	SPECIAL*
IM1S	BONE	SPECIAL*
IM1 AL	IMPL	IMPLANT
IM2A	IMPL	IMPLANT
IM2A-15	IMPL	IMPLANT
IM2P	IMPL	IMPLANT
IM2P-15	IMPL	IMPLANT
IM2.8A	IMPL	IMPLANT
IM2.8P	IMPL	IMPLANT
IM3A	IMPL	IMPLANT
IM3A -15	IMPL	IMPLANT
IM3P	IMPL	IMPLANT
IM3P-15	IMPL	IMPLANT
IM3.4A	IMPL	IMPLANT
IM3.4P	IMPL	IMPLANT
IM4A	IMPL	IMPLANT
IM4P	IMPL	IMPLANT
P2-3	IMPL	IMPLANT
P3-4	IMPL	IMPLANT
IM1 SP	IMPL	IMPLANT
IM2 SP	IMPL	IMPLANT
P2-3 SP	IMPL	IMPLANT

→ INSERT MODE POWER

### OSTEOTOMY

	BONE	SPONGIOUS / CORTICAL
OT1	BONE	SPONGIOUS / CORTICAL
OT1A	BONE	SPONGIOUS / CORTICAL
OT2	BONE	SPONGIOUS / CORTICAL
OT3	BONE	SPONGIOUS / CORTICAL
OT4	BONE	SPONGIOUS / CORTICAL
OT5	BONE	SPONGIOUS / CORTICAL
OT5A	BONE	SPONGIOUS / CORTICAL
OT5B	BONE	SPONGIOUS / CORTICAL
OT6	BONE	SPONGIOUS / CORTICAL
OT7	BONE	SPONGIOUS / CORTICAL
OT7A	BONE	SPONGIOUS / CORTICAL
OT7S-3	BONE	SPECIAL*
OT7S-4	BONE	SPECIAL*
OT7-20	BONE	SPONGIOUS / CORTICAL
OT8L	BONE	SPONGIOUS / CORTICAL
OT8R	BONE	SPONGIOUS / CORTICAL
OT9	BONE	SPONGIOUS / CORTICAL
OT11	BONE	SPONGIOUS / CORTICAL
OT12	BONE	SPONGIOUS / CORTICAL
OT12S	BONE	SPECIAL*
OT13	BONE	SPONGIOUS / CORTICAL
OT14	BONE	SPONGIOUS / CORTICAL
SLO-H	BONE	SPONGIOUS / CORTICAL
PL1	BONE	SPONGIOUS / CORTICAL
PL2	BONE	SPONGIOUS / CORTICAL
PL3	BONE	SPONGIOUS / CORTICAL

### OSTEOPLASTY

	BONE	SPONGIOUS / CORTICAL
OP1	BONE	SPONGIOUS / CORTICAL
OP2	BONE	SPONGIOUS / CORTICAL
OP3	BONE	SPONGIOUS / CORTICAL
OP3A	BONE	SPONGIOUS / CORTICAL
OP4	BONE	SPONGIOUS / CORTICAL
OP5	ROOT	PERIO
OP5A	ROOT	PERIO
	BONE	SPECIAL
OP6	ROOT	PERIO
OP6A	ROOT	PERIO
OP7	BONE	SPONGIOUS / CORTICAL
OP8	ROOT	PERIO
	BONE	SPECIAL
OP9	BONE	SPONGIOUS / CORTICAL
SLC	BONE	SPONGIOUS / CORTICAL

### MINI IMPLANT PREP

	IMPL	IMPLANT
MDI 1.9	IMPL	IMPLANT
MDI 2.2	IMPL	IMPLANT
MDI 2.5	IMPL	IMPLANT

→ INSERT MODE POWER

### SINUS MEMBRANE ELEVATION

	ROOT	ENDO*
EL1	ROOT	ENDO*
EL2	ROOT	ENDO*
EL3	ROOT	ENDO*
SLS	BONE	SPECIAL*
SLE1	BONE	SPECIAL*
SLE2	BONE	SPECIAL*

### PERIOSTEUM

	BONE	SPONGIOUS / CORTICAL
PR1	BONE	SPONGIOUS / CORTICAL
PR2	BONE	SPONGIOUS / CORTICAL

### ENDO RETRO

	ROOT	ENDO*
EN1	ROOT	ENDO*
EN2	ROOT	ENDO*
EN3	ROOT	ENDO*
EN4	ROOT	ENDO*
EN5R	ROOT	ENDO*
EN5L	ROOT	ENDO*
EN6R	ROOT	ENDO*
EN6L	ROOT	ENDO*

### EXTRACTION

	BONE	SPONGIOUS / CORTICAL
EX1	BONE	SPONGIOUS / CORTICAL
EX2	BONE	SPONGIOUS / CORTICAL
EX3	BONE	SPONGIOUS / CORTICAL

### EXPLANTATION

	BONE	SPECIAL / SPONGIOUS / CORTICAL
EXP3-R	BONE	SPECIAL / SPONGIOUS / CORTICAL
EXP3-L	BONE	SPECIAL / SPONGIOUS / CORTICAL
EXP4-R	BONE	SPECIAL / SPONGIOUS / CORTICAL
EXP4-L	BONE	SPECIAL / SPONGIOUS / CORTICAL

### PERIO

	ROOT	PERIO
PP1	ROOT	PERIO
PS1	ROOT	PERIO
PS2	ROOT	PERIO
PS6	ROOT	PERIO
PP10	ROOT	PERIO
PP11	ROOT	PERIO
PP12	ROOT	PERIO

### IMPLANT CLEANING

	ROOT	ENDO / PERIO
ICP + IC1	ROOT	ENDO / PERIO

### RESTORATIVE

	ROOT	PERIO
DB2	ROOT	PERIO
	BONE	SPECIAL

\*Maximum power permitted

# APPROPRIATE SETTINGS FOR THE INSERTS



## PIEZOSURGERY® II

→ INSERT MODE POWER\*\*

### IMPLANT PREP

INSERT	MODE	POWER**
IM1S	BONE	SPECIAL*
IM1 AL	BONE	3 / 2 / 1
IM2A	BONE	3 / 2 / 1
IM2A-15	BONE	3 / 2 / 1
IM2P	BONE	3 / 2 / 1
IM2P-15	BONE	3 / 2 / 1
IM2.8A	BONE	3 / 2 / 1
IM2.8P	BONE	3 / 2 / 1
IM3A	BONE	3 / 2 / 1
IM3A -15	BONE	3 / 2 / 1
IM3P	BONE	3 / 2 / 1
IM3P-15	BONE	3 / 2 / 1
IM3.4A	BONE	3 / 2 / 1
IM3.4P	BONE	3 / 2 / 1
IM4A	BONE	3 / 2 / 1
IM4P	BONE	3 / 2 / 1
P2-3	BONE	3 / 2 / 1
P3-4	BONE	3 / 2 / 1
IM1 SP	BONE	3 / 2 / 1
IM2 SP	BONE	3 / 2 / 1
P2-3 SP	BONE	3 / 2 / 1

→ INSERT MODE POWER\*\*

### OSTEOTOMY

OT1	BONE	3 / 2 / 1
OT1A	BONE	3 / 2 / 1
OT2	BONE	3 / 2 / 1
OT3	BONE	3 / 2 / 1
OT4	BONE	3 / 2 / 1
OT5	BONE	3 / 2 / 1
OT5A	BONE	3 / 2 / 1
OT5B	BONE	3 / 2 / 1
OT6	BONE	3 / 2 / 1
OT7	BONE	3 / 2 / 1
OT7A	BONE	3 / 2 / 1
OT7S-3	BONE	SPECIAL*
OT7S-4	BONE	SPECIAL*
OT7-20	BONE	3 / 2 / 1
OT8L	BONE	3 / 2 / 1
OT8R	BONE	3 / 2 / 1
OT9	BONE	3 / 2 / 1
OT11	BONE	3 / 2 / 1
OT12	BONE	3 / 2 / 1
OT12S	BONE	SPECIAL*
OT13	BONE	3 / 2 / 1
OT14	BONE	3 / 2 / 1
SLO-H	BONE	3 / 2 / 1
PL1	BONE	3 / 2 / 1
PL2	BONE	3 / 2 / 1
PL3	BONE	3 / 2 / 1

### OSTEOPLASTY

OP1	BONE	3 / 2 / 1
OP2	BONE	3 / 2 / 1
OP3	BONE	3 / 2 / 1
OP3A	BONE	3 / 2 / 1
OP4	BONE	3 / 2 / 1
OP5	ROOT	PERIO
OP5A	ROOT	PERIO
OP6	BONE	SPECIAL
OP6A	ROOT	PERIO
OP7	BONE	3 / 2 / 1
OP9	BONE	3 / 2 / 1
SLC	BONE	3 / 2 / 1

### MINI IMPLANT PREP

MDI 1.9	BONE	3 / 2 / 1
MDI 2.2	BONE	3 / 2 / 1
MDI 2.5	BONE	3 / 2 / 1

→ INSERT MODE POWER\*\*

### SINUS MEMBRANE ELEVATION

EL1	ROOT	ENDO*
EL2	ROOT	ENDO*
EL3	ROOT	ENDO*
SLS	BONE	SPECIAL 1
SLE1	BONE	SPECIAL 1
SLE2	BONE	SPECIAL 1

### PERIOSTEUM

PR1	BONE	3 / 2 / 1
PR2	BONE	3 / 2 / 1

### ENDO RETRO

EN1	ROOT	ENDO*
EN2	ROOT	ENDO*
EN3	ROOT	ENDO*
EN4	ROOT	ENDO*
EN5R	ROOT	ENDO*
EN5L	ROOT	ENDO*
EN6R	ROOT	ENDO*
EN6L	ROOT	ENDO*

### EXTRACTION

EX1	BONE	3 / 2 / 1
EX2	BONE	3 / 2 / 1
EX3	BONE	3 / 2 / 1

### EXPLANTATION

EXP3-R	BONE	SPECIAL / 3 / 2 / 1
EXP3-L	BONE	SPECIAL / 3 / 2 / 1
EXP4-R	BONE	SPECIAL / 3 / 2 / 1
EXP4-L	BONE	SPECIAL / 3 / 2 / 1

### PERIO

PP1	ROOT	PERIO
PS1	ROOT	PERIO
PS2	ROOT	PERIO
PS6	ROOT	PERIO
PP10	ROOT	PERIO
PP11	ROOT	PERIO
PP12	ROOT	PERIO

### IMPLANT CLEANING

ICP + IC1	ROOT	ENDO / PERIO
-----------	------	--------------

### RESTORATIVE

DB2	ROOT	PERIO
	BONE	SPECIAL

\* Maximum power permitted

\*\* Power: 1 = max 2 = med 3 = min



## PIEZOSURGERY®

→ INSERT MODE POWER

### IMPLANT PREP

INSERT	MODE	POWER
IM1S	BOOSTED	C
IM1 AL	BOOSTED	C
IM2A	BOOSTED	C
IM2A-15	BOOSTED	C
IM2P	BOOSTED	C
IM2P-15	BOOSTED	C
IM2.8A	BOOSTED	C
IM2.8P	BOOSTED	C
IM3A	BOOSTED	C
IM3A -15	BOOSTED	C
IM3P	BOOSTED	C
IM3P-15	BOOSTED	C
IM3.4A	BOOSTED	C
IM3.4P	BOOSTED	C
IM4A	BOOSTED	C
IM4P	BOOSTED	C
P2-3	BOOSTED	C
P3-4	BOOSTED	C
IM1 SP	BOOSTED	C
IM2 SP	BOOSTED	C
P2-3 SP	BOOSTED	C

→ INSERT MODE POWER

### OSTEOTOMY

INSERT	MODE	POWER
OT1	BOOSTED	C
OT1A	BOOSTED	C
OT2	BOOSTED	C
OT3	BOOSTED	C
OT4	BOOSTED	C
OT5	BOOSTED	C
OT5A	BOOSTED	C
OT5B	BOOSTED	C
OT6	BOOSTED	C
OT7	BOOSTED	C
OT7A	BOOSTED	C
OT75-3	BOOSTED	C
OT75-4	BOOSTED	C
OT7-20	BOOSTED	C
OT8L	BOOSTED	C
OT8R	BOOSTED	C
OT9	BOOSTED	C
OT11	BOOSTED	C
OT12	BOOSTED	C
OT12S	BOOSTED	C
OT13	BOOSTED	C
OT14	BOOSTED	C
SLO-H	BOOSTED	C
PL1	BOOSTED	C
PL2	BOOSTED	C
PL3	BOOSTED	C

### OSTEOPLASTY

INSERT	MODE	POWER
OP1	BOOSTED	C
OP2	BOOSTED	C
OP3	BOOSTED	C
OP3A	BOOSTED	C
OP4	BOOSTED	C
OP5	HIGH	2 - 3
OP5A	HIGH	2 - 3
OP6	ROOT	2 - 3
OP6A	ROOT	2 - 3
OP7	BOOSTED	C
OP9	BOOSTED	C
SLC	BOOSTED	C

### MINI IMPLANT PREP

INSERT	MODE	POWER
MDI 1.9	BOOSTED	C
MDI 2.2	BOOSTED	C
MDI 2.5	BOOSTED	C

→ INSERT MODE POWER

### SINUS MEMBRANE ELEVATION

INSERT	MODE	POWER
EL1	LOW	1
EL2	LOW	1
EL3	LOW	1
SLS	BOOSTED	C
SLE1	BOOSTED	C
SLE2	BOOSTED	C

### PERIOSTEUM

INSERT	MODE	POWER
PR1	BOOSTED	C
PR2	BOOSTED	C

### ENDO RETRO

INSERT	MODE	POWER
EN1	LOW	1
EN2	LOW	1
EN3	LOW	1
EN4	LOW	1
EN5R	LOW	1
EN5L	LOW	1
EN6R	LOW	1
EN6L	LOW	1

### EXTRACTION

INSERT	MODE	POWER
EX1	BOOSTED	C
EX2	BOOSTED	C
EX3	BOOSTED	C

### EXPLANTATION

INSERT	MODE	POWER
EXP3-R	BOOSTED	C
EXP3-L	BOOSTED	C
EXP4-R	BOOSTED	C
EXP4-L	BOOSTED	C

### PERIO

INSERT	MODE	POWER
PP1	HIGH	2 - 3
PS1	HIGH	2 - 3
PS2	HIGH	2 - 3
PS6	HIGH	2 - 3
PP10	HIGH	2 - 3
PP11	HIGH	2 - 3
PP12	HIGH	2 - 3

### IMPLANT CLEANING

INSERT	MODE	POWER
ICP + IC1	HIGH	2 - 3
	LOW	1

### RESTORATIVE

INSERT	MODE	POWER
DB2	HIGH	2 - 3
	BOOSTED	A

# IMPLANT SITE PREPARATION SEQUENCE

## PIEZOSURGERY® IMPLANT SITE PREPARATION INSERTS

IMPLANTS 3.2 – 3.3		IMPLANTS 3.7 – 3.8		IMPLANTS 4.0 – 4.1		IMPLANTS 4.8 – 5.0	
INSERT SEQUENCE	BONE QUALITY	INSERT SEQUENCE	BONE QUALITY	INSERT SEQUENCE	BONE QUALITY	INSERT SEQUENCE	BONE QUALITY
IM1S		IM1S		IM1S		IM1S	
IM2	L	IM2		IM2		IM2	
P2-3*		P2-3*		P2-3*		P2-3*	
IM2.8	M	IM2.8	L	IM3	L	IM3	
IM3	H	IM3	M	P3-4*		P3-4*	
		P3-4*		IM3.4	M	IM4	L M
		IM3.4	H	CORTICAL BONE TAP TOOL	H	CORTICAL BONE TAP TOOL	H

L	low bone density
M	medium bone density
H	hard bone density

\* only crestal cortical





mectron s.p.a.,  
via Loreto 15/A, 16042 Carasco (Ge), Italia,  
tel +39 0185 35361, fax +39 0185 351374

→ [www.mectron.com](http://www.mectron.com) or [mectron@mectron.com](mailto:mectron@mectron.com)

© Copyright mectron S.p.A., Carasco, Italy  
All rights reserved. Texts, pictures and graphics of mectron brochures are protected by copyright and other protection laws. Without written approval of mectron S.p.A. the contents may not be copied, distributed, changed or made available to third parties for commercial purposes.

